

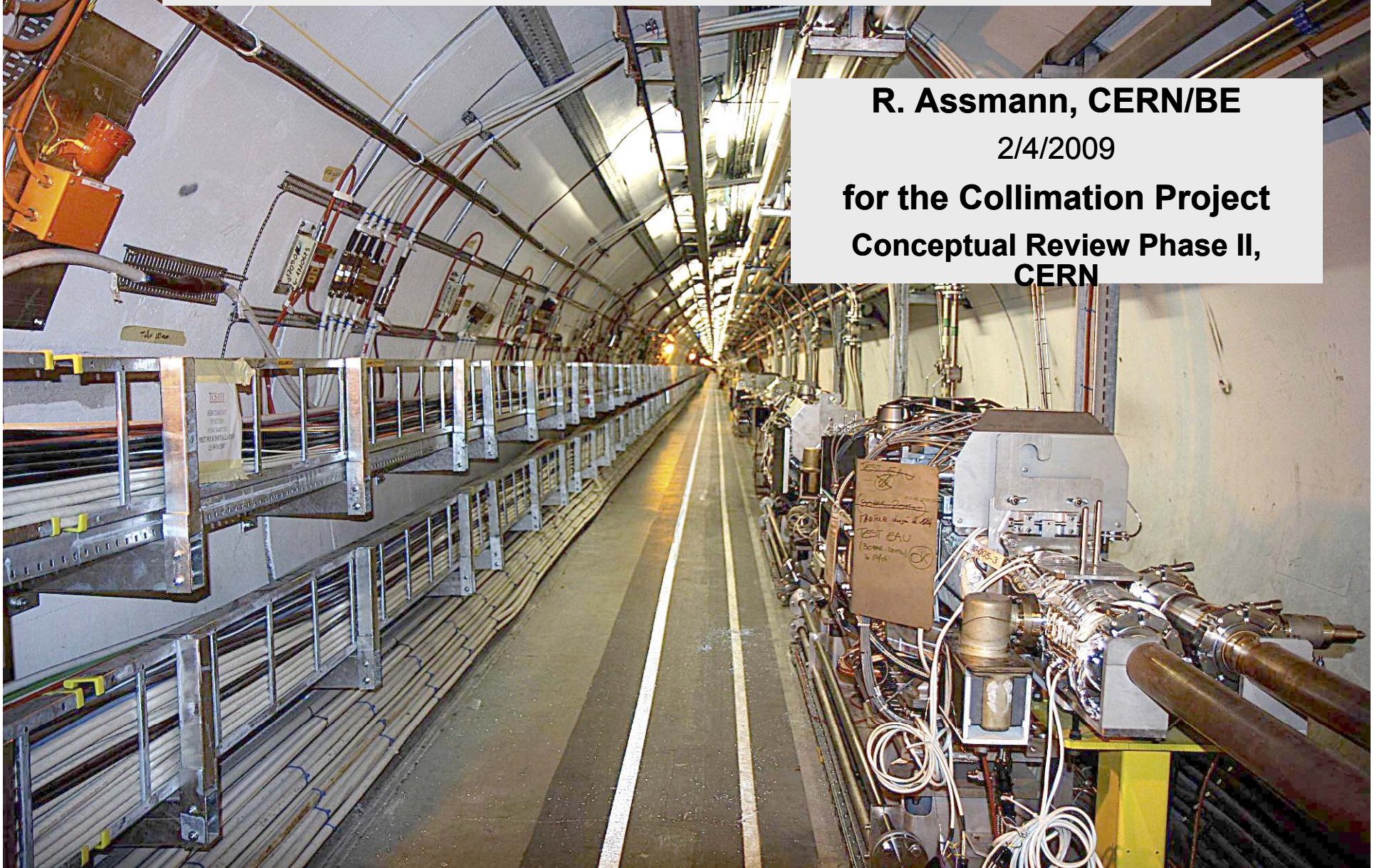

# The Conceptual Solution for LHC Collimation Phase II



**R. Assmann, CERN/BE**  
2/4/2009  
**for the Collimation Project**  
**Conceptual Review Phase II,**  
**CERN**





# Introduction



- Large proton and ion accelerators for particle and nuclear physics **push the intensity frontier** (LHC, FAIR, ...).
- Higher beam intensity means **higher luminosity** in colliders and **higher energy density and particle fluxes** in and from targets.
- E.g. particle physics requires higher luminosity (and hence intensity) with increased beam energy. Intensity increases faster than beam energy.
- Basic questions:
  - How to intercept unavoidable beam losses with high efficiency (**collimation**) and how to protect the accelerator against damage (**machine protection**)?
  - What materials to use closest to the particle beams (**radiation damage, vacuum properties, electro-magnetic properties and effects on beams, survival to thermal shocks**).
- **Synergies** with R&D for fusion and fission reactors.

# The LHC Extrapolation

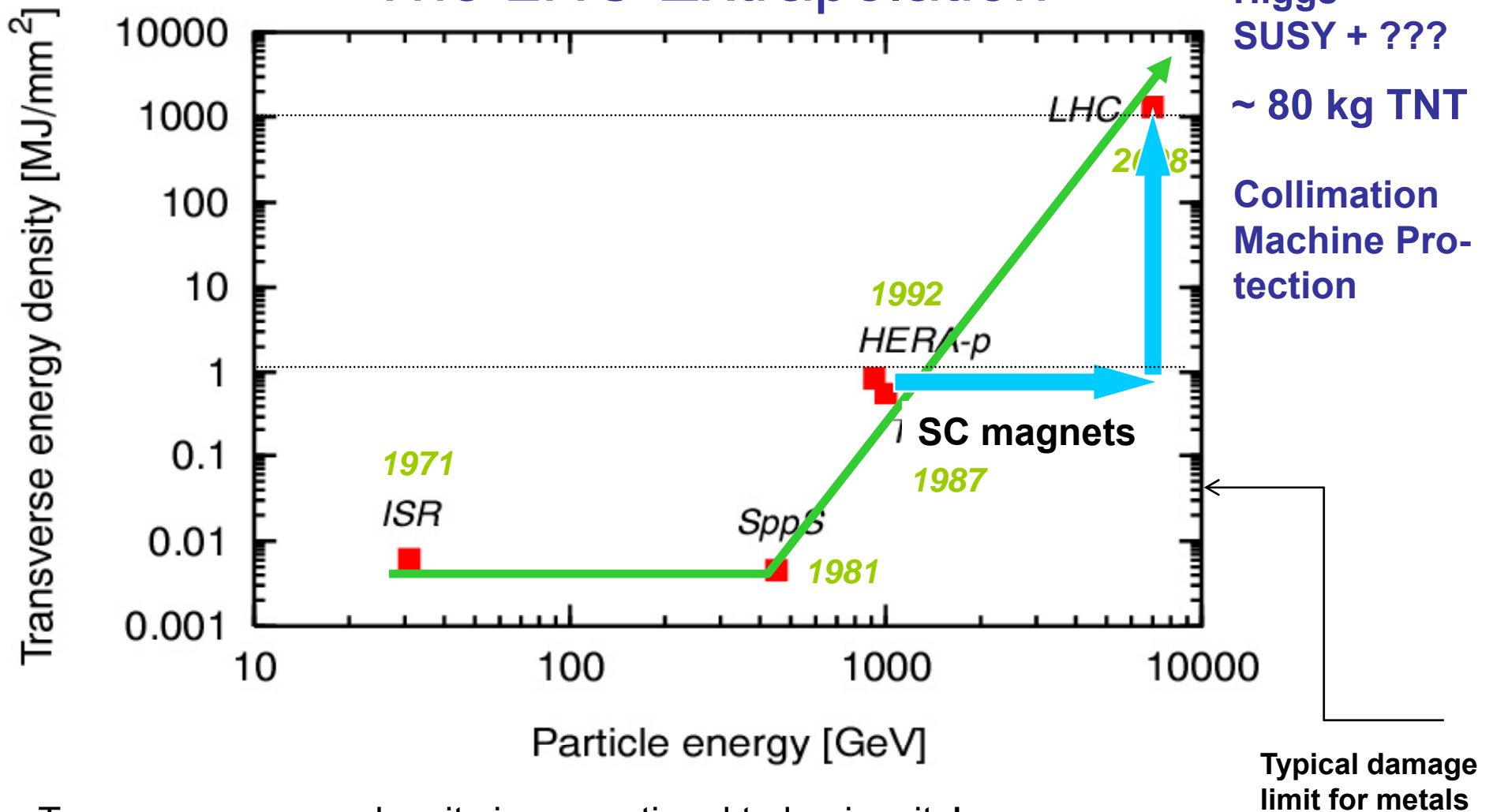

Transverse energy density is proportional to luminosity!

The “new Livingston plot” of proton colliders: **Advancing into unknown territory!**



# Handling High Power



- LHC high power beams:
  - Ideally no power lost (protons stored with infinite lifetime).
- Collimators are the LHC defense against unavoidable losses:
  - Irregular fast losses and failures: [Passive protection](#).
  - Slow losses: [Cleaning and absorption of losses](#) in super-conducting environment.
  - [Radiation](#): Managed by collimators.
  - [Particle physics background](#): Minimized.
- Realistically:
  - Slow losses: **0.5 – 1.0 MW onto collimators** (up to 10 s)
  - Fast losses: up to **1 MJ in 200 ns into 0.2 mm<sup>2</sup>**



# Major Function: Preventing Quenches



- Shock beam impact: **2 MJ/mm<sup>2</sup> in 200 ns (0.5 kg TNT)**
- Maximum beam loss at 7 TeV: 1% of beam equally lost over 10 s

**500 kW**

- Quench limit of SC LHC magnet:

**8.5 W/m**

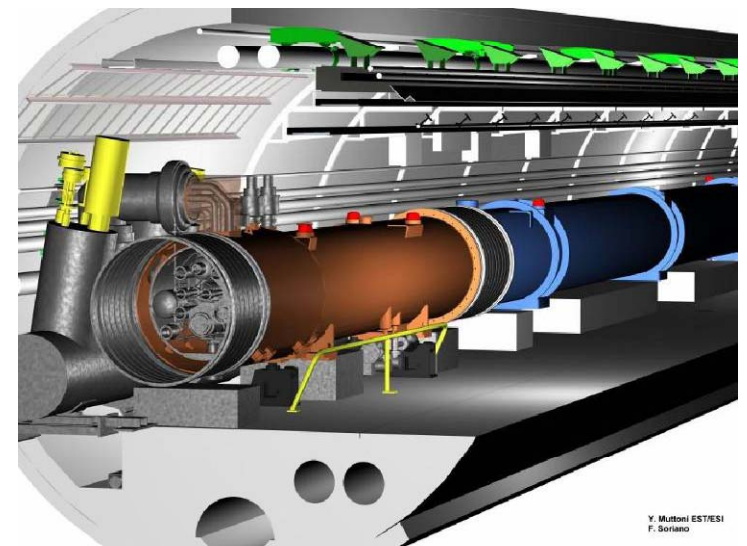



# Constraints Collimation Phase I



- Strict constraints imposed in 2003 for phase 1 system:
  - Availability of working collimation system for LHC beam start-up
  - Robustness against LHC beam (avoid catastrophic problems)
  - Radiation handling (access for later improvements)
  - No modifications to SC areas (due to short time and problems with QRL)
- Compromises accepted:
  - Limited advanced features (e.g. no pick-ups in jaws).
  - Risk due to radiation damage for fiber-reinforced graphite (electrical + thermal conductivity changes, dust, swelling, ...). Kurchatov data shows factor 4-5 changes with irradiation in various important parameters.
  - Steep increase in machine impedance due to collimators.
  - Excellent cleaning efficiency, however, insufficient for nominal intensity.

**→ Phase 2 was part of the concept from the start!**



“Phase 1”



Momentum Collimation

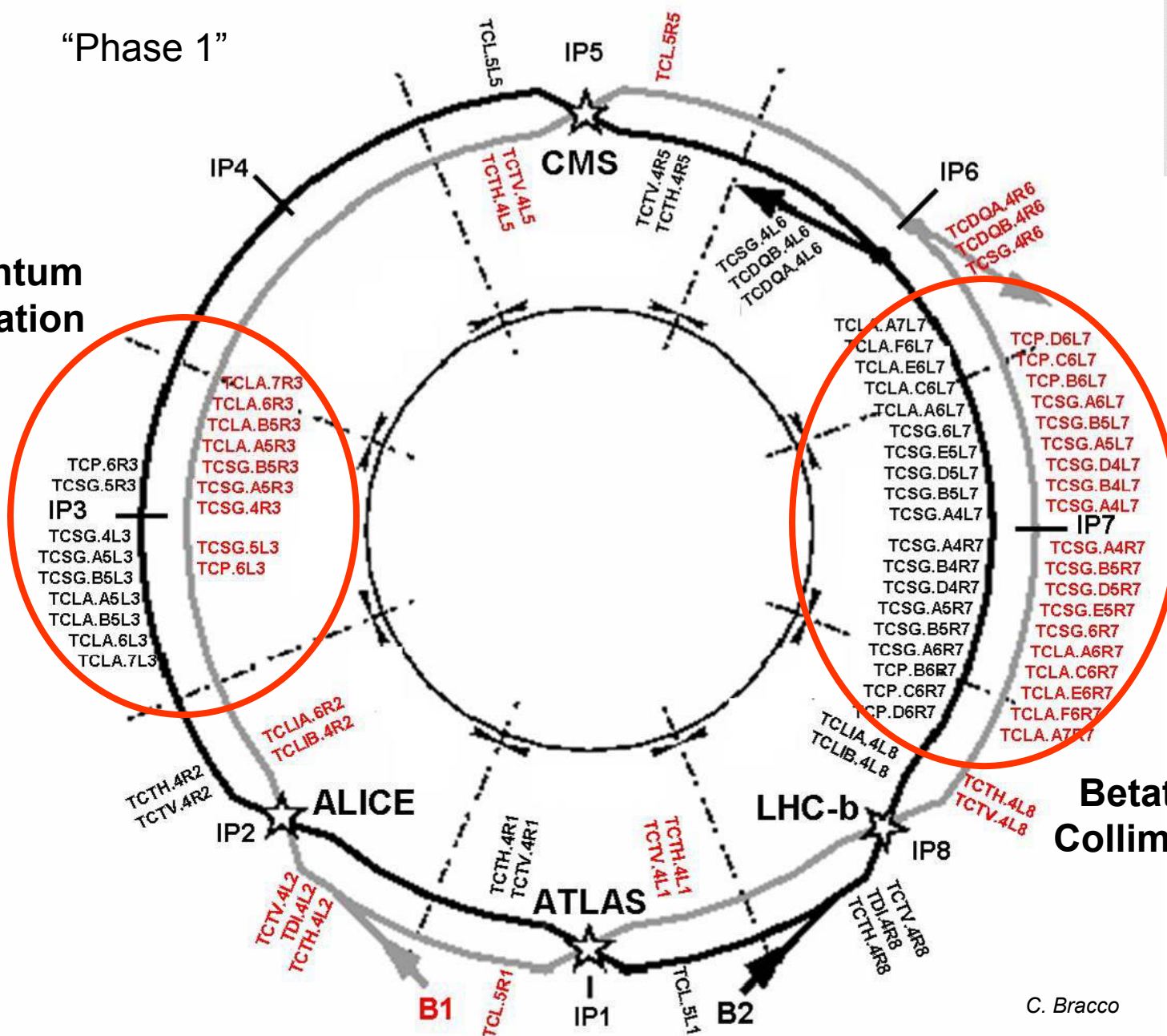

C. Bracco



# Multi-Stage Cleaning & Protection

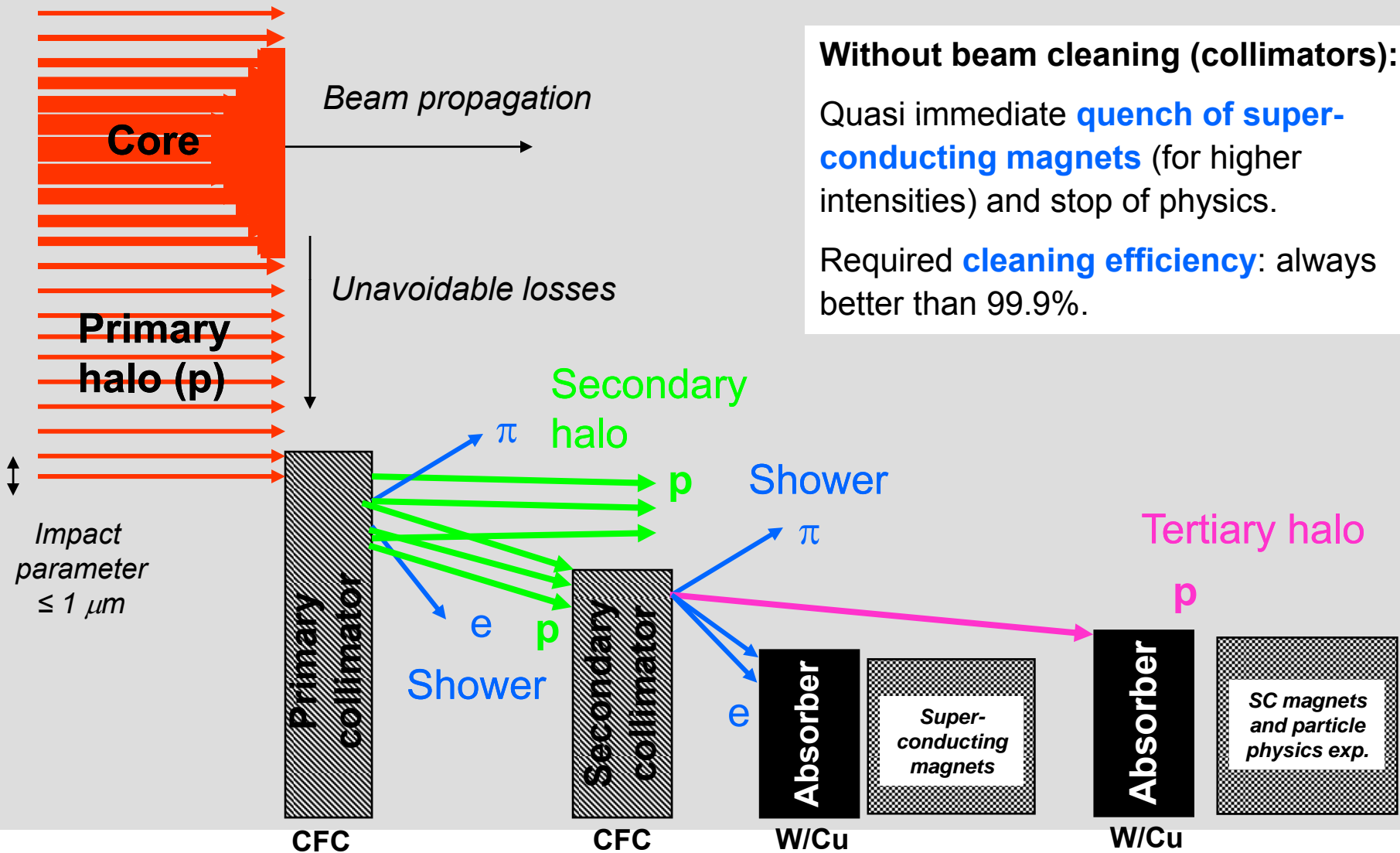

**Without beam cleaning (collimators):**

Quasi immediate **quench of super-conducting magnets** (for higher intensities) and stop of physics.

Required **cleaning efficiency**: always better than 99.9%.





# The LHC Phase I Collimation Choices



- Low Z materials closest to the beam:
  - **Survival** of materials with direct beam impact
  - Improved **cleaning efficiency**
  - High **transparency**: 95% of energy leaves jaw
- Distributing losses over ~250 m long *dedicated* cleaning insertions:
  - Average load  **$\leq 2.5$  kW per m** for a 500 kW loss.
  - No risk of quenches in **normal-conducting magnets**.
  - Hot spots protected by passive **absorbers** outside of vacuum.
- Capturing residual energy flux by high Z absorbers:
  - Preventing losses into **super-conducting region** after collimator insertions.
  - Protecting expensive magnets **against damage**.
- No shielding of collimators:
  - As a result **radiation spread more equally** in tunnel.
  - Lower **peak doses**.
  - Fast and **remote handling possible** for low weight collimators.



# What is in the Tunnel



- Collimation phases defined before the LHC upgrade was phased.
- Important:
  - **Phase I is the initial collimation installation** in the tunnel!
  - **Phase II is the upgrade for nominal and ultimate** beam intensities!
  - This is different to insertions:  
Phase 0 in tunnel, phase I triplet upgrade, phase II upgrade.
- Present production and installation in the tunnel:
  - **112 phase I collimators (10 types) and absorbers in LHC and transfer line** (108 installed for 2009/10 run, 4 delayed due to conflict with TOTEM).
  - 19 phase I collimators as spares for operation.
  - **38 tunnel locations** equipped with cables, water connections, vacuum pumping, instrumentation and replacement chambers (**preparation phase II**).
- Concept: Limited phase I but evolutionary upgrade...



# Status Phase I

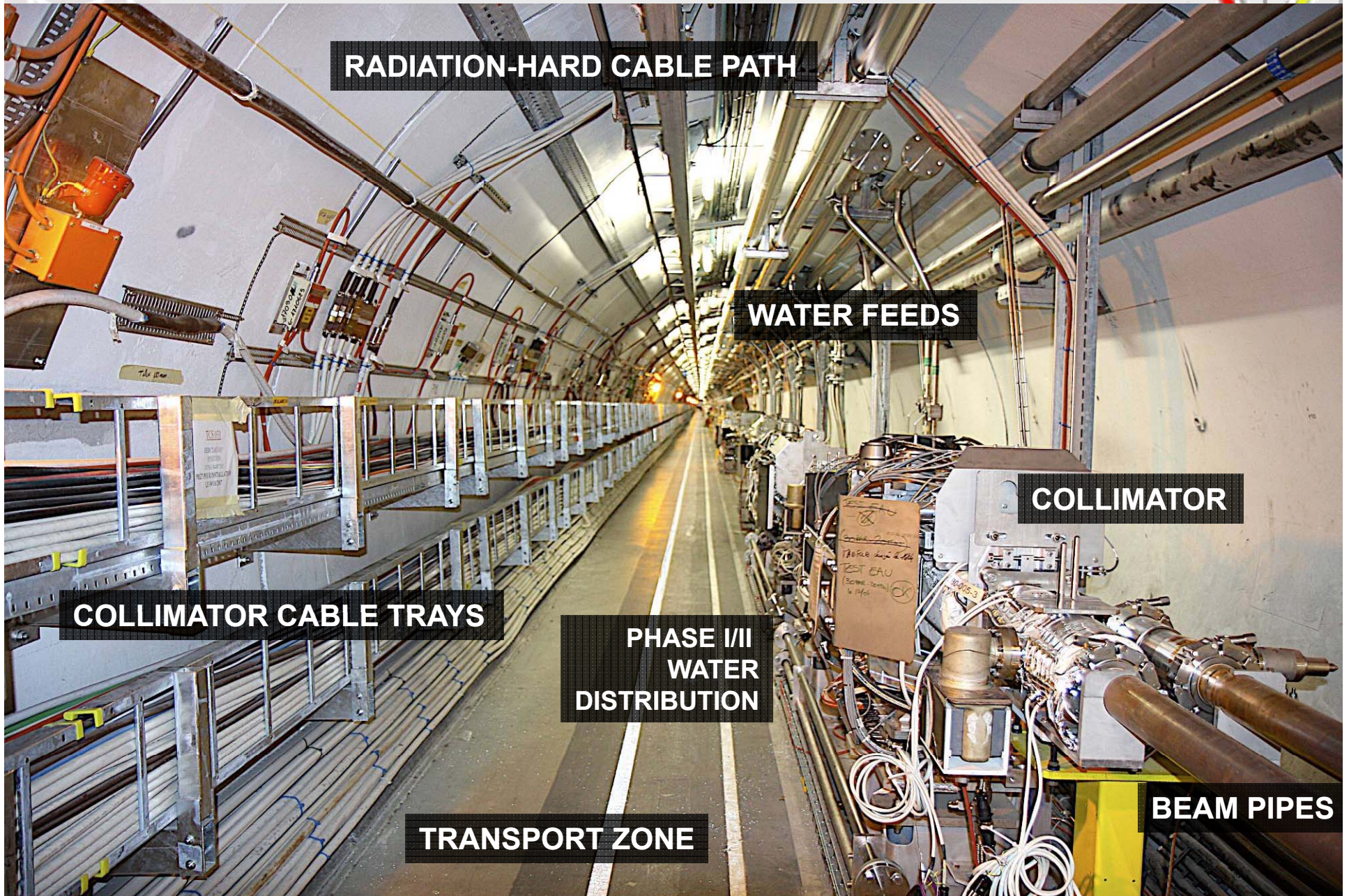

**RADIATION-HARD CABLE PATH**

**WATER FEEDS**

**COLLIMATOR**

**COLLIMATOR CABLE TRAYS**

**PHASE I/II  
WATER  
DISTRIBUTION**

**TRANSPORT ZONE**

**BEAM PIPES**



# Side View Phase I Collimator

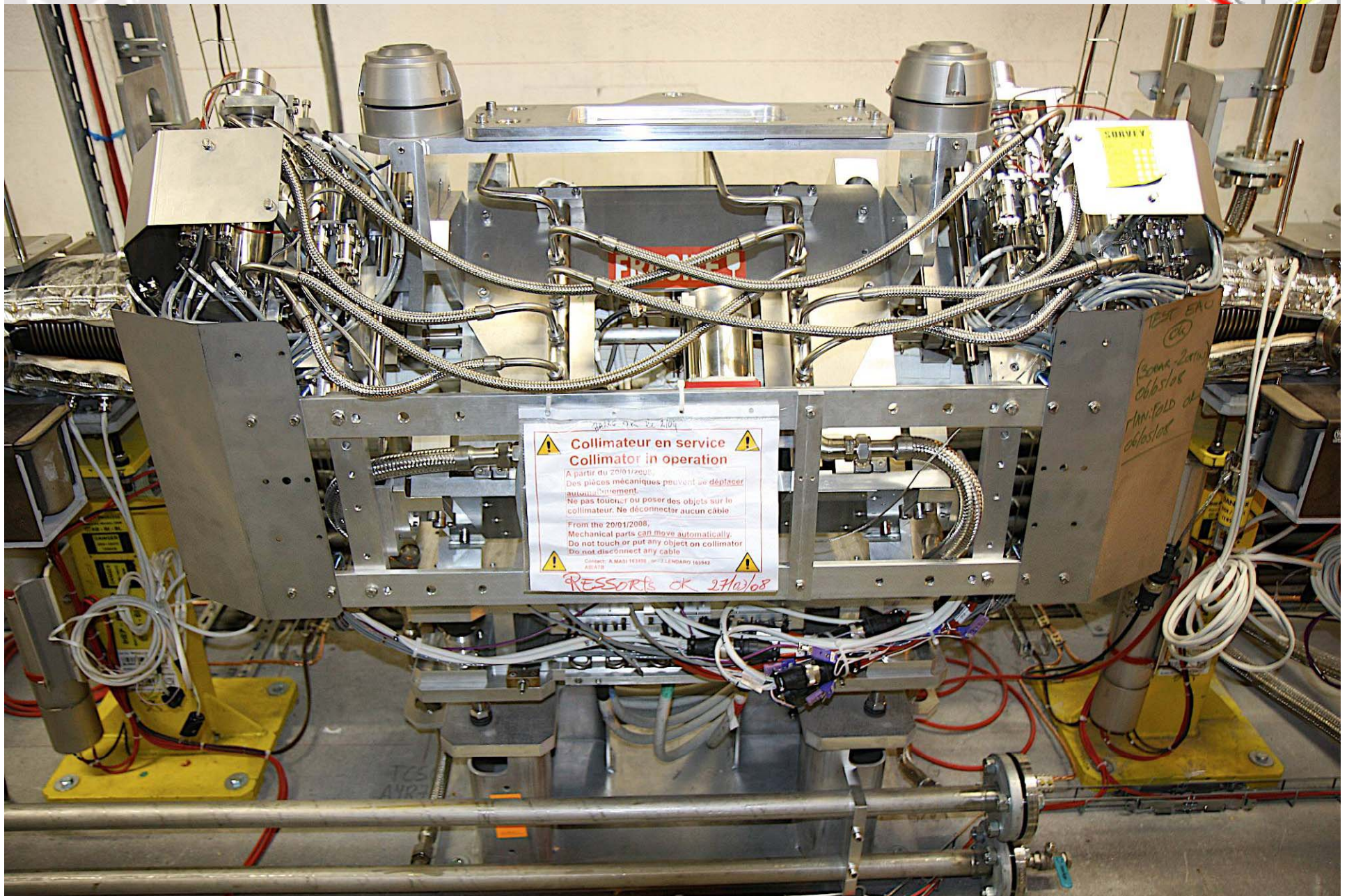





# The LHC "TCSG" Secondary Collimator

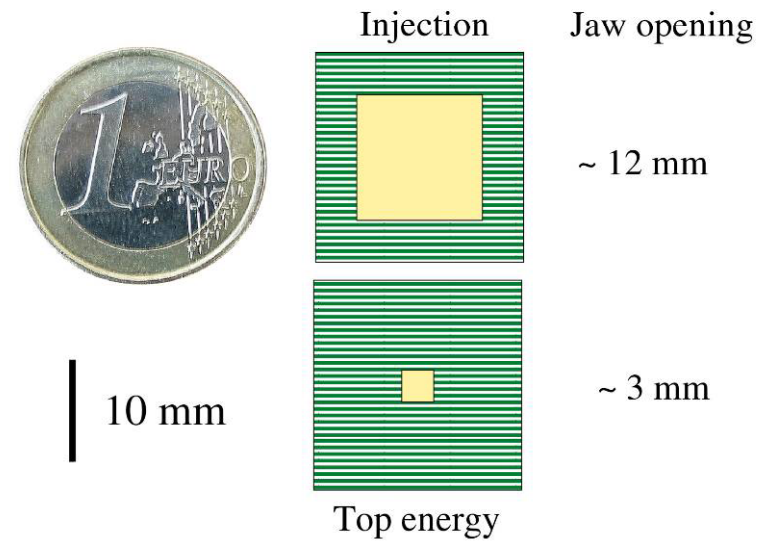
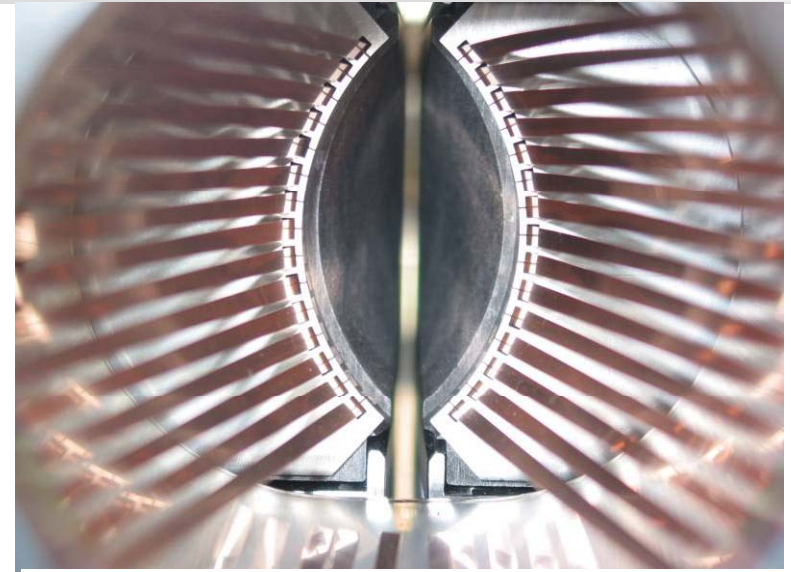
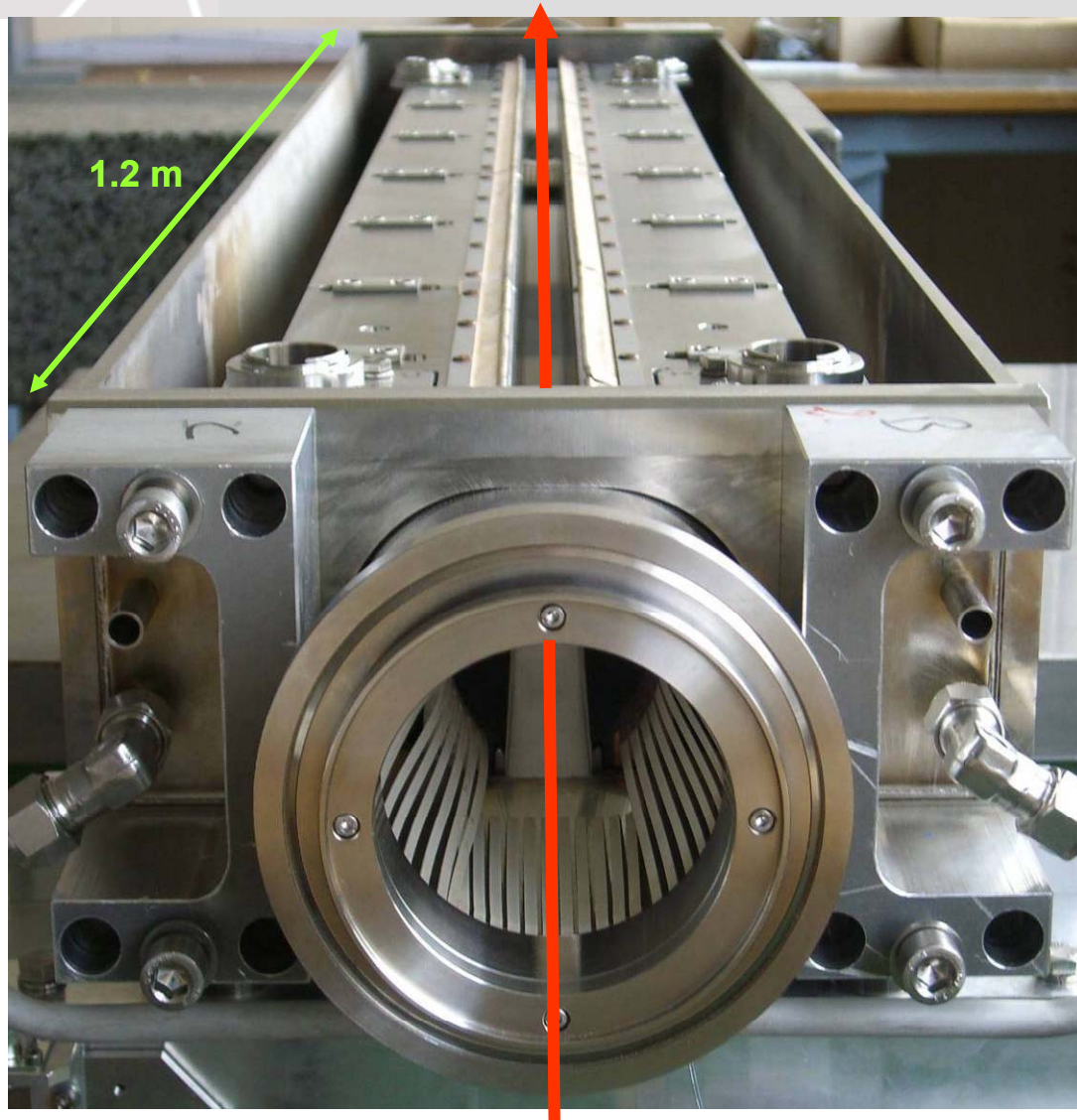

**360 MJ proton beam**

R. Assmann, CERN



# Example: 3 Primary Collimators IR7

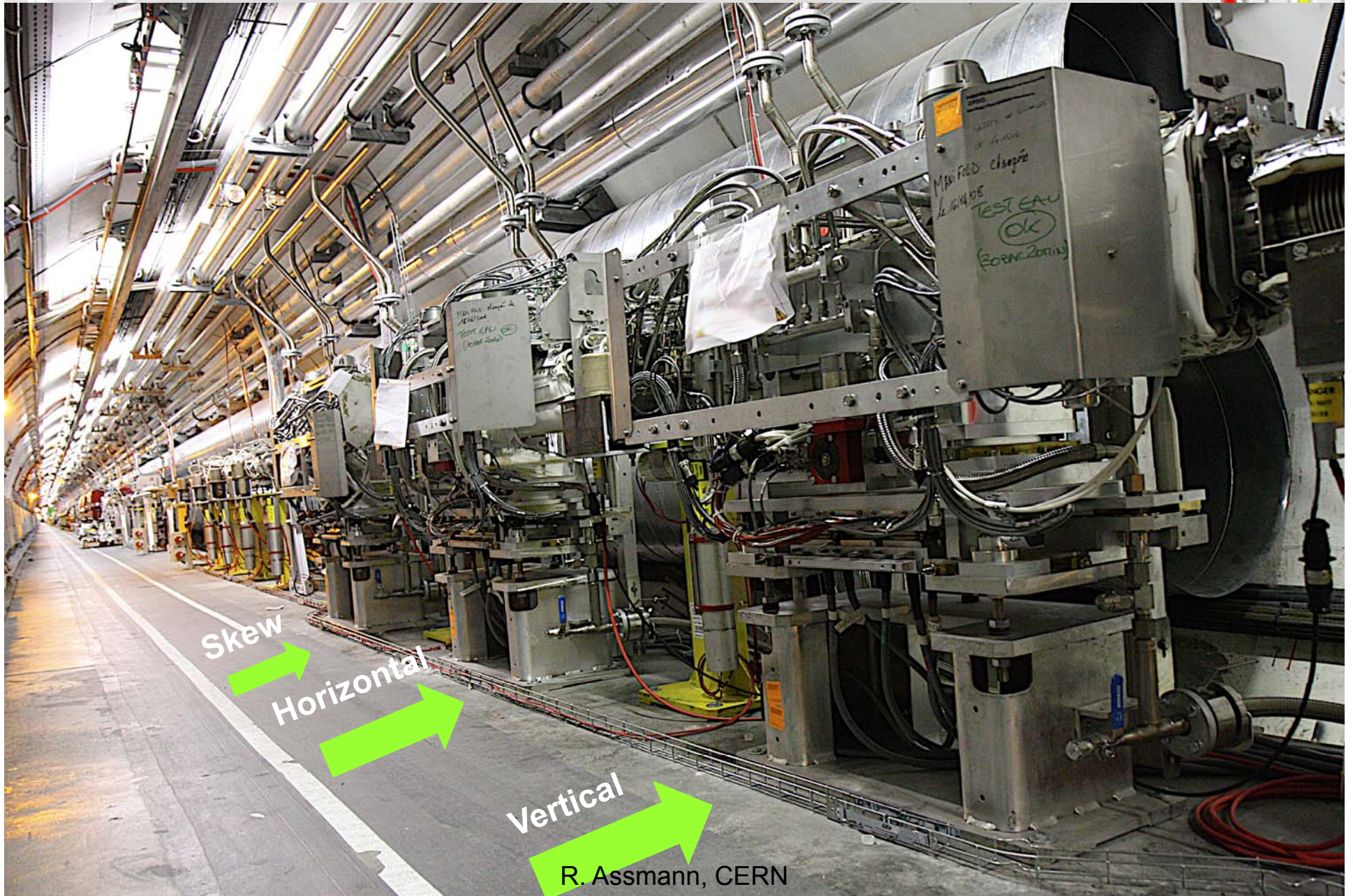



# Collimator Operation

1<sup>st</sup> Beam Day; Use as Target/Stopper

Collimator in IP5 closed

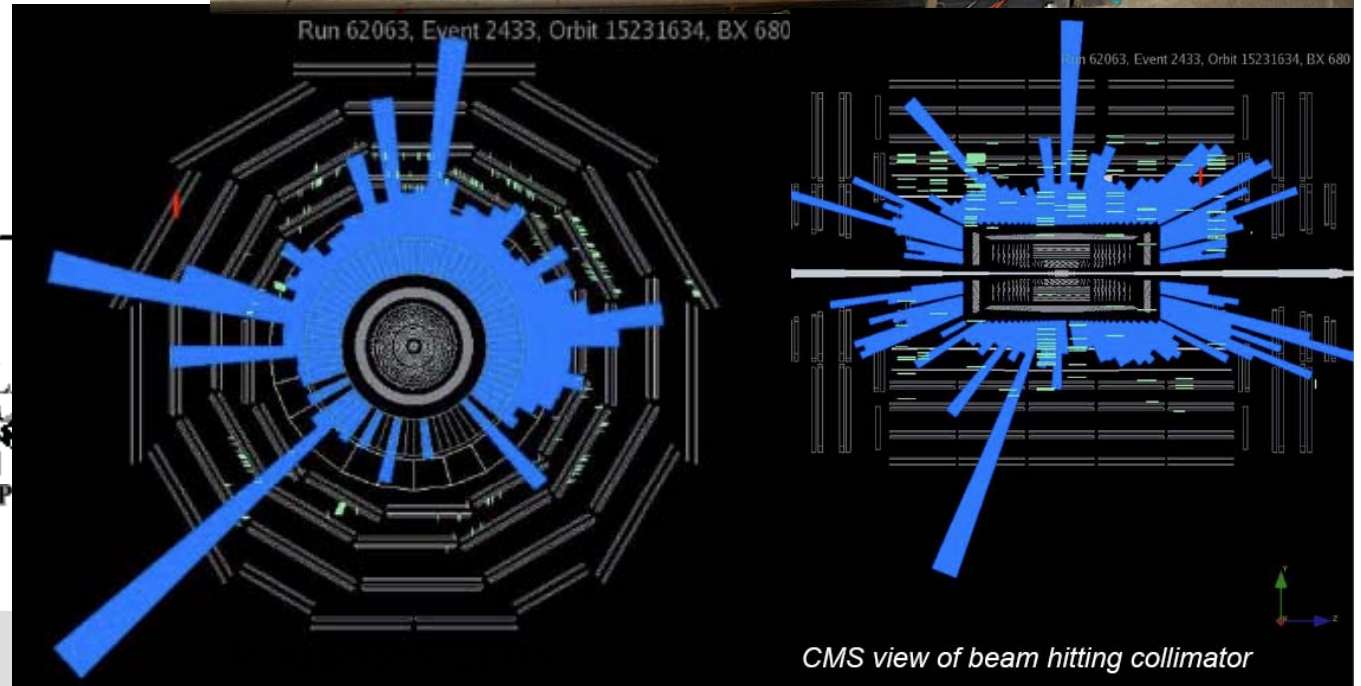
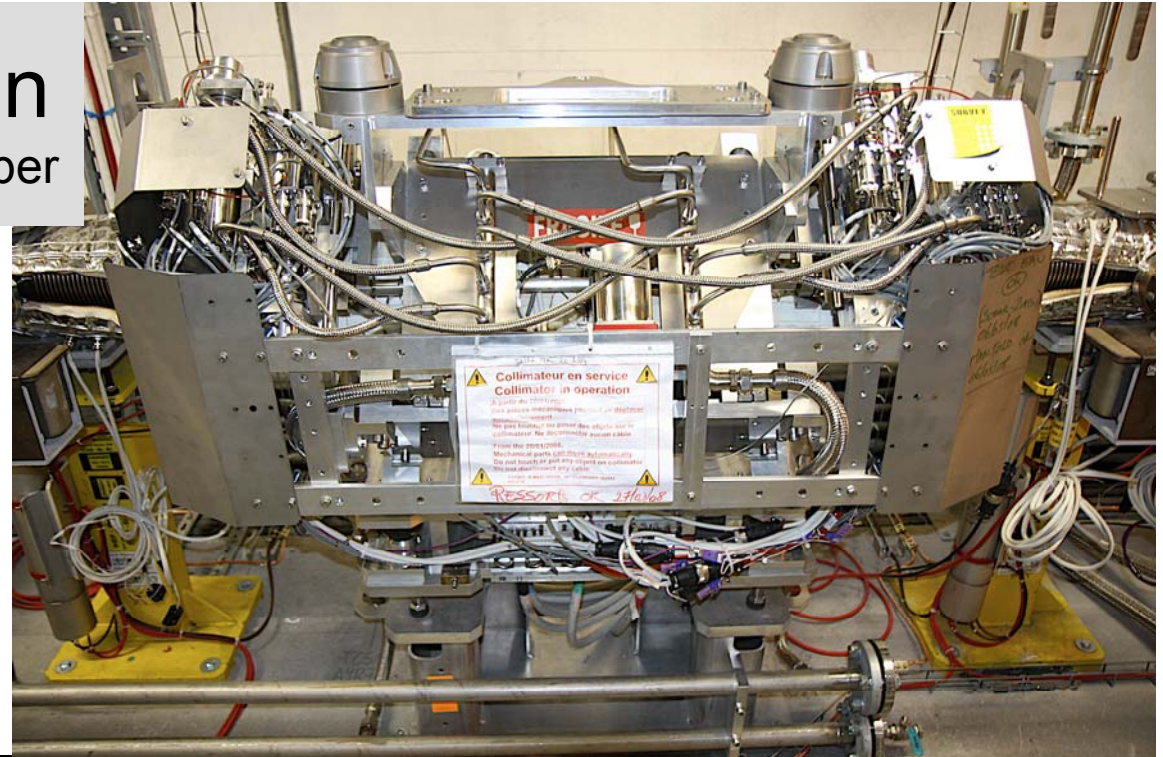
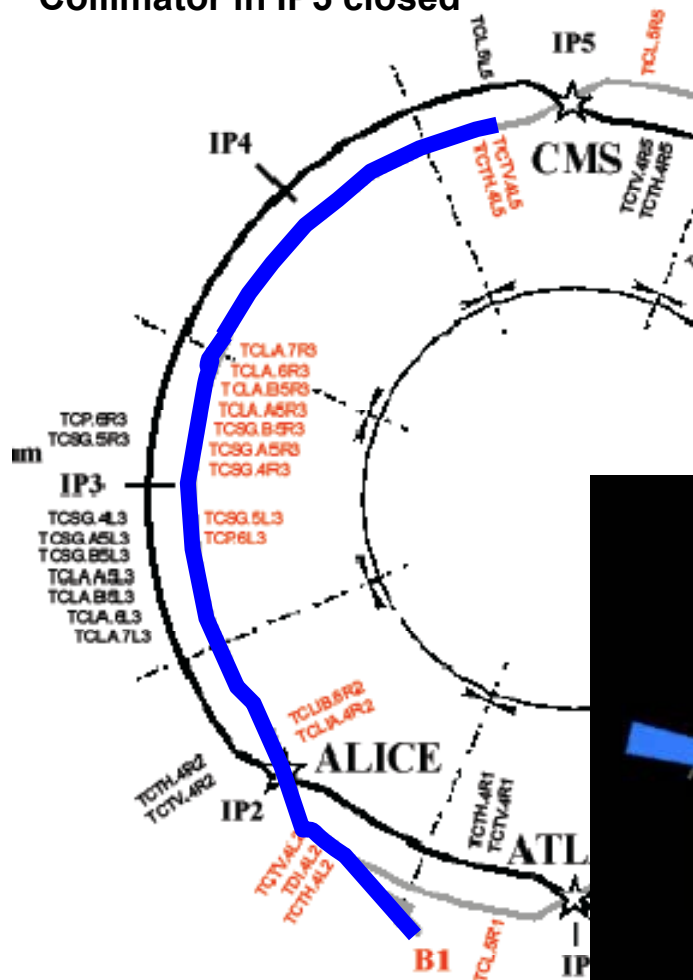

Interesting now...

Background later...

CMS view of beam hitting collimator



# Collimator Operatio

(without beam, after incident)

Moving **56 collimator jaws over 10 days** through operational cycle. No feedback on motor settings.

Recording **maximum measured error** in jaw position.

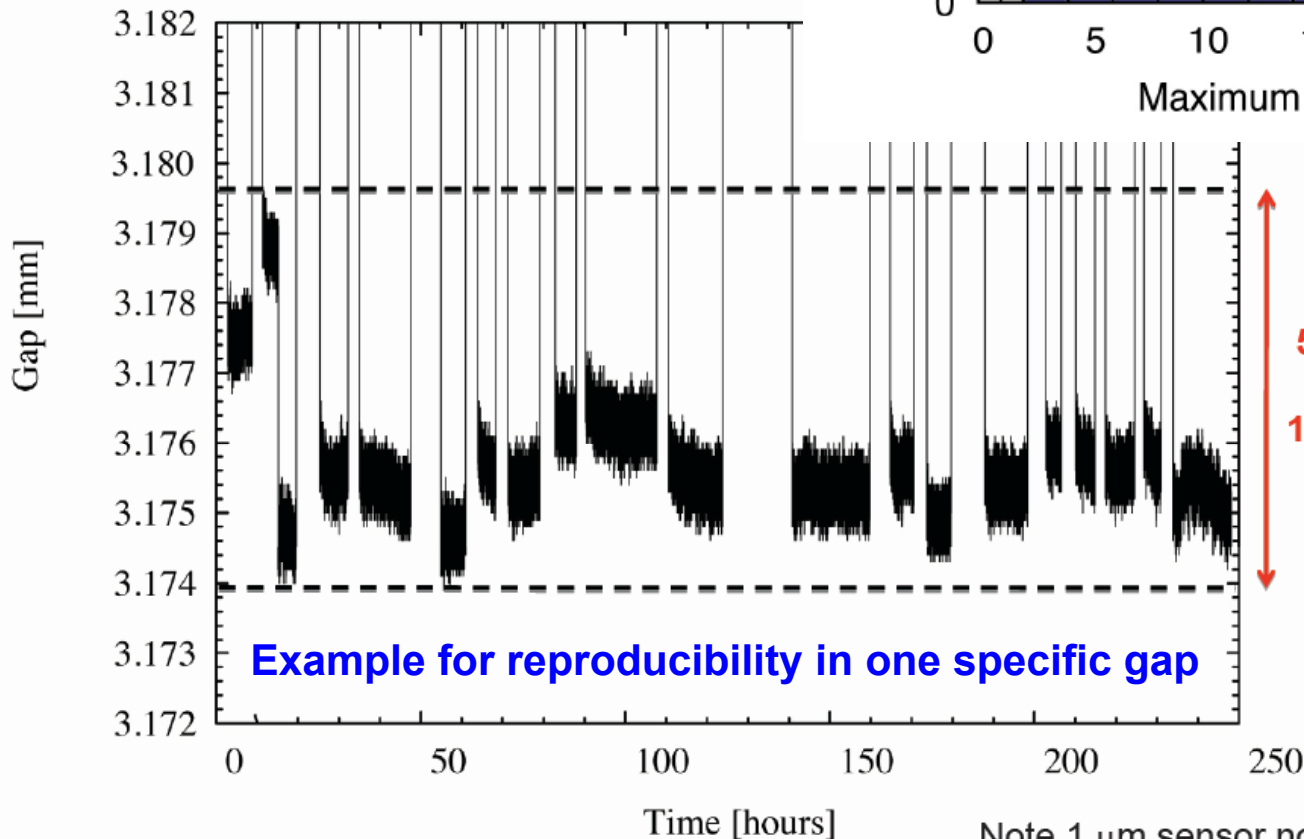
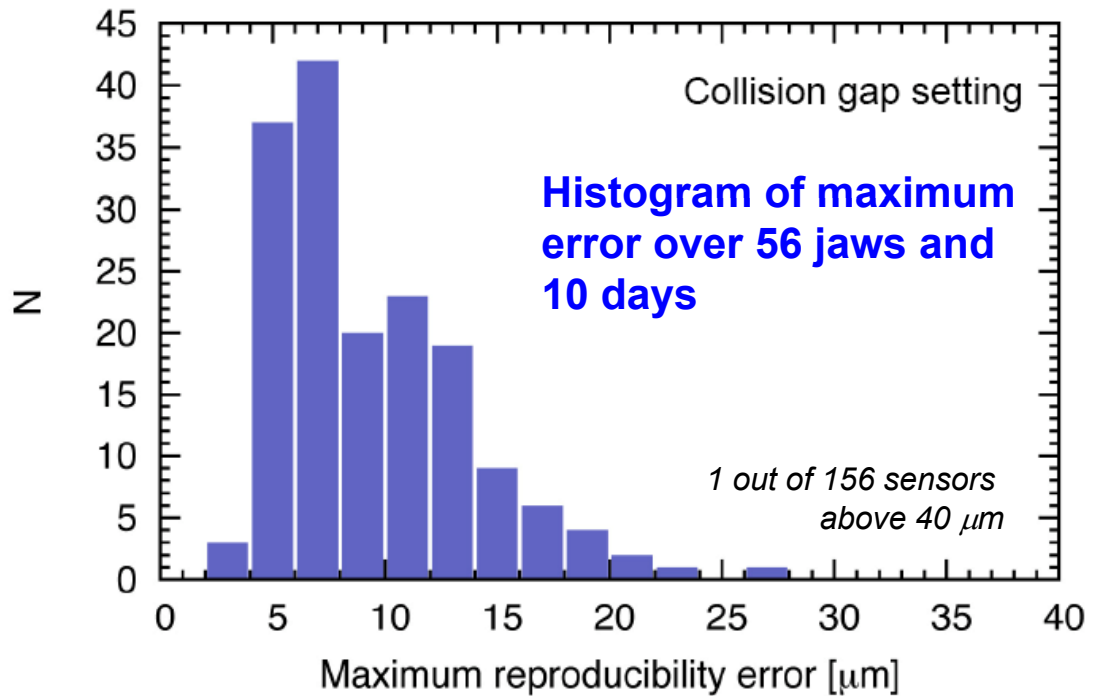

Note 1  $\mu\text{m}$  sensor noise.

Sum of **mechanical, motor, sensor and controls errors** below width of human hair for 10 day operation without readjustment!

Gives **good hopes** for LHC beam cleaning!





# Phase II Secondary Collimator Slots

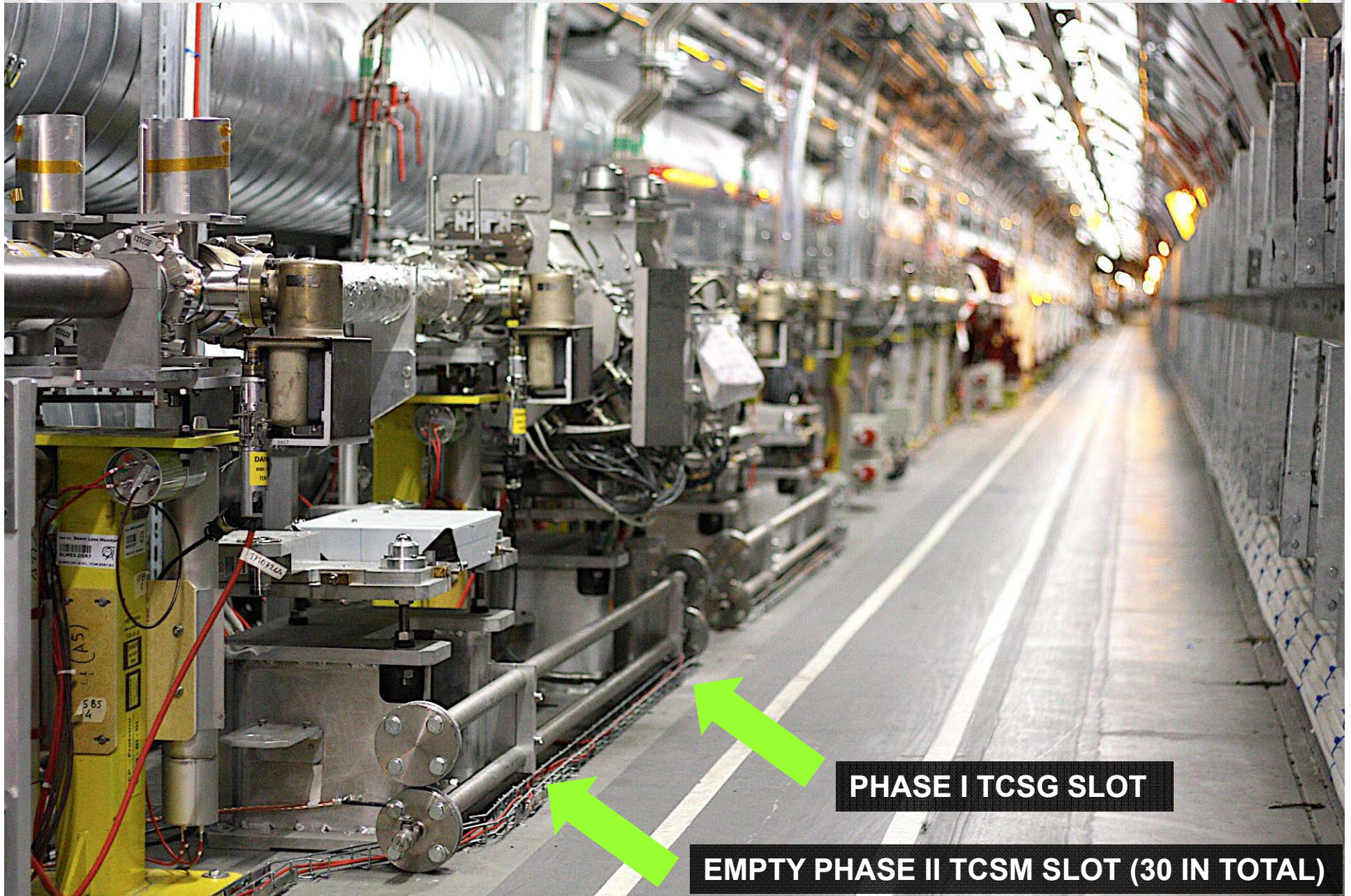
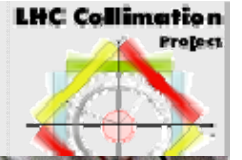

**PHASE I TCSG SLOT**

**EMPTY PHASE II TCSM SLOT (30 IN TOTAL)**





# Phase II Beam Scraper Slots

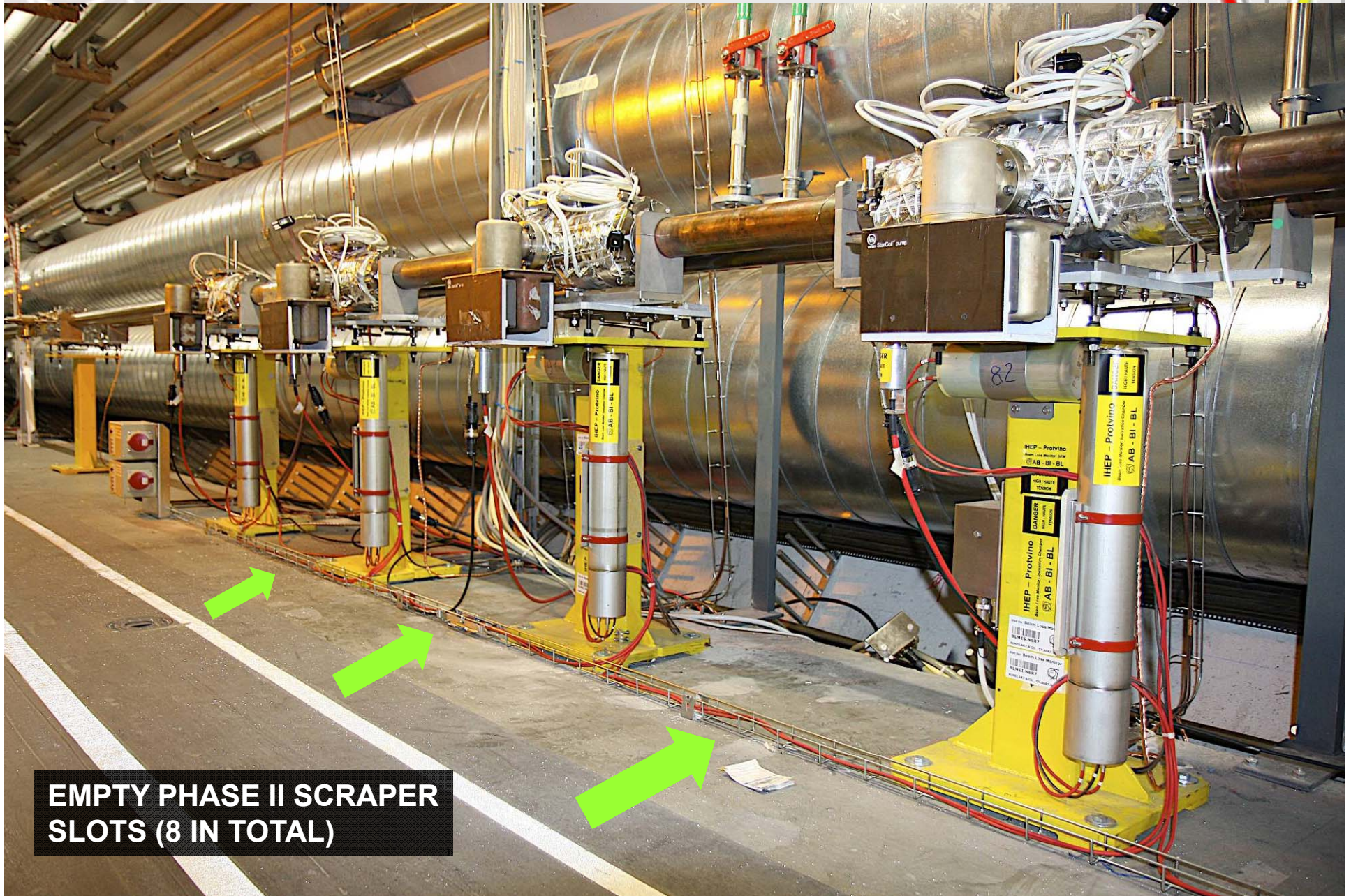
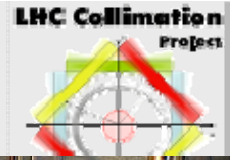

**EMPTY PHASE II SCRAPER SLOTS (8 IN TOTAL)**





# Phase II Collimation Project



- Phase 2 collimation project on R&D has been included into the white paper:
  - We set up **project structure** in January 2008. Key persons in place. Work packages agreed.
  - Two lines: (1) Upgrade of collimation and improved hardware. (2) Preparation of beam test stand for test of advanced collimators.
  - Review in February 2009 to take first decisions.
- US effort (LARP, SLAC) is ongoing. First basic prototype results shown at EPAC08.
- FP7 request EUCARD with collimation work package:
  - Makes **available significant additional resources** (enhancing white paper money).
  - Remember: Advanced collimation resources through FP7 (**cryogenic collimators with GSI, crystal collimation, e-beam scraper, ...**).



# Results of SPC Review Panel 2007



CERN/SPC/883  
Original: English  
21 March 2007

ORGANISATION EUROPEENNE POUR LA RECHERCHE NUCLEAIRE  
**CERN** EUROPEAN ORGANIZATION FOR NUCLEAR RESEARCH

---

SCIENTIFIC POLICY COMMITTEE

Report of the SPC Review Panel on extra resources 2008-2010

## 1.6 Collimation System

Luminosity improvement in the short term will require an upgrade of the initial collimation system. The phase I collimation system is adequate for lower beam intensities, but only the Phase II collimation system will be able to handle the nominal beam intensities.

R. Assmann, CERN





# Project Plan July 2007 (sent to DG)



## Deliverables

The work for phase 2 collimation has four major deliverables which are listed below with the target dates for completion in brackets:

Deliverable 1: Conceptual and technical design of phase 2 collimators (3/09).

Deliverable 2: Phase 2 prototypes, tested and ready for installation (9/09).

Deliverable 3: Beam test stand (450 GeV) for collimators operational (8/09).

Deliverable 4: Beam qualification (test stand and LHC) of phase 2 collimators (10/10).



# Project Plan July 2007 (sent to DG)

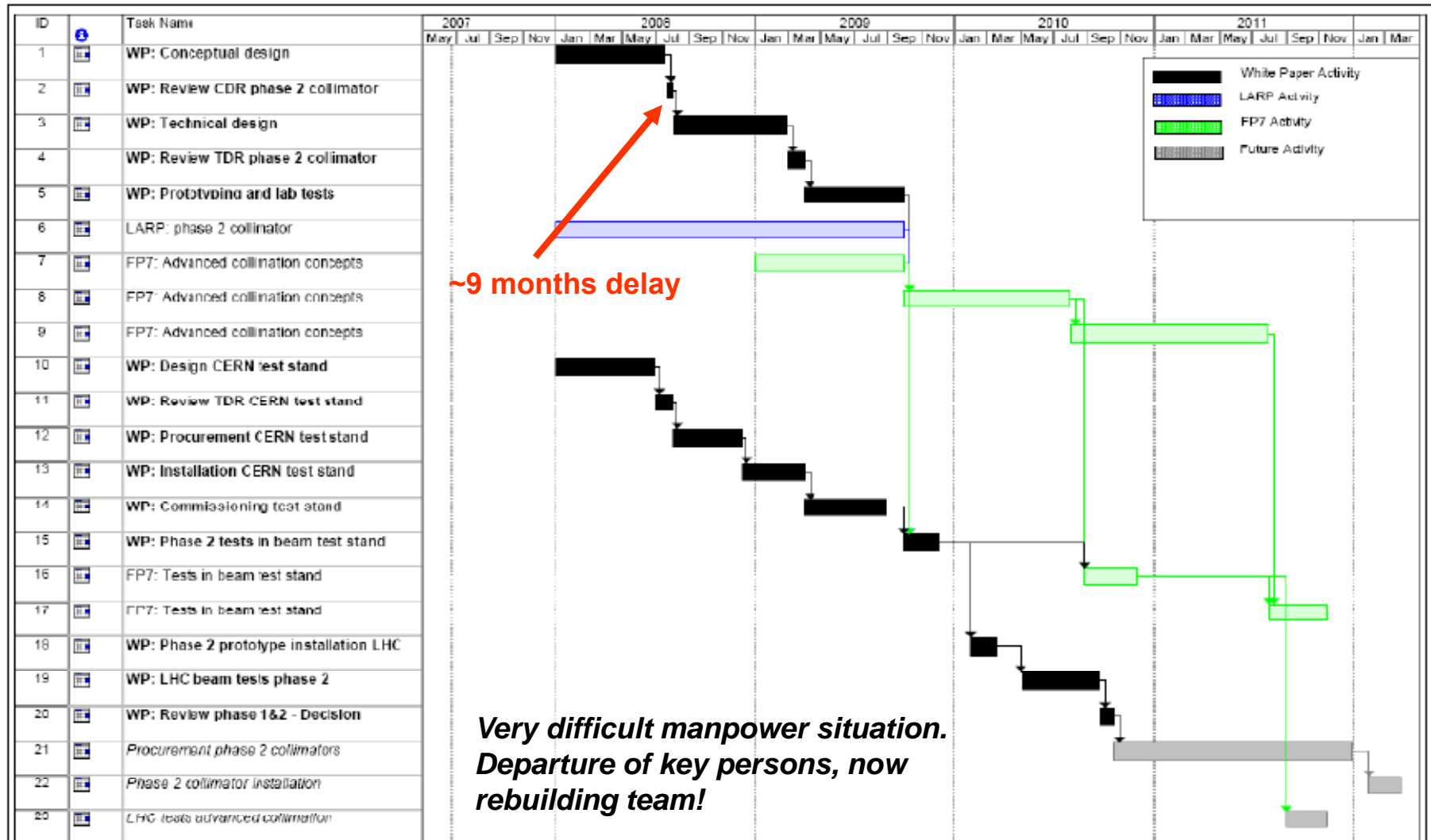



# Conceptual Review Phase II Collimation



- Despite very tight manpower we found the time to work out a **conceptual solution for reaching nominal and ultimate intensities in the LHC**. Many thanks to all of you who helped.
- Now: **Have solution reviewed and start technical design work, if our proposals are supported.**
- What this review is: Collect and present solutions for all known problems (p, ions, experiments). **Present a conceptual solution and readiness for starting technical design work.**
- What this review is not: Detailed decision on technical choices e.g. for jaw material of phase II secondary jaws. **Presentation of technical designs, costs, assessment of resulting work for the super-conducting ring.**
- Following along our **project plan**, as discussed in AB and the LHC project and as sent to the DG in 2007.



# Limitations and Solutions



- 1. Cleaning Efficiency**
- 2. Impedance**
- 3. Operational Efficiency**
- 4. Radiation Damage**





# Issue 1: Cleaning Efficiency



- Always announced that **Phase I is insufficient for nominal LHC intensity** (“ideal performance reach of 40%”, “usually lower in reality”).
- Model of LHC and its aperture used for **halo tracking**.
- **Imperfections included** from metrology measurements, tunnel alignment and SPS results for collimator positioning accuracy. Consider these realistic imperfections.
- **High performance, massively parallel computing** (35M p over 200 turns → 190,000 proton-km simulated)! Moved onto the Grid.



# Some Terminology



- Cleaning inefficiency:

$$\text{Inefficiency} = \frac{\text{Number escaped particles}}{\text{Number impacting particles}} \times \frac{1}{\text{Loss length}}$$

*Goals: Intercept and catch impacting particles.  
Dilute escaping particles (increase loss length).*

- Intensity reach:

$$\text{Max Intensity} = \frac{\text{Quench limit} \times \text{BLM threshold factor}}{\text{Inefficiency} \times \text{Peak loss rate}}$$

*Used to calculate target inefficiency ( $\sim 2e-5/m$ ) for nominal intensity ( $3.2e14 p$ ).*

- Assumptions:

- Quench limits and BLM threshold factor (1/3) specified and assumed known.
- Fractional peak beam loss rate unknown. From experience assume 0.001/s  
→ 1% of beam lost uniformly over 10 s.



# Impact of Imperfections on Inefficiency (Leakage Rate)

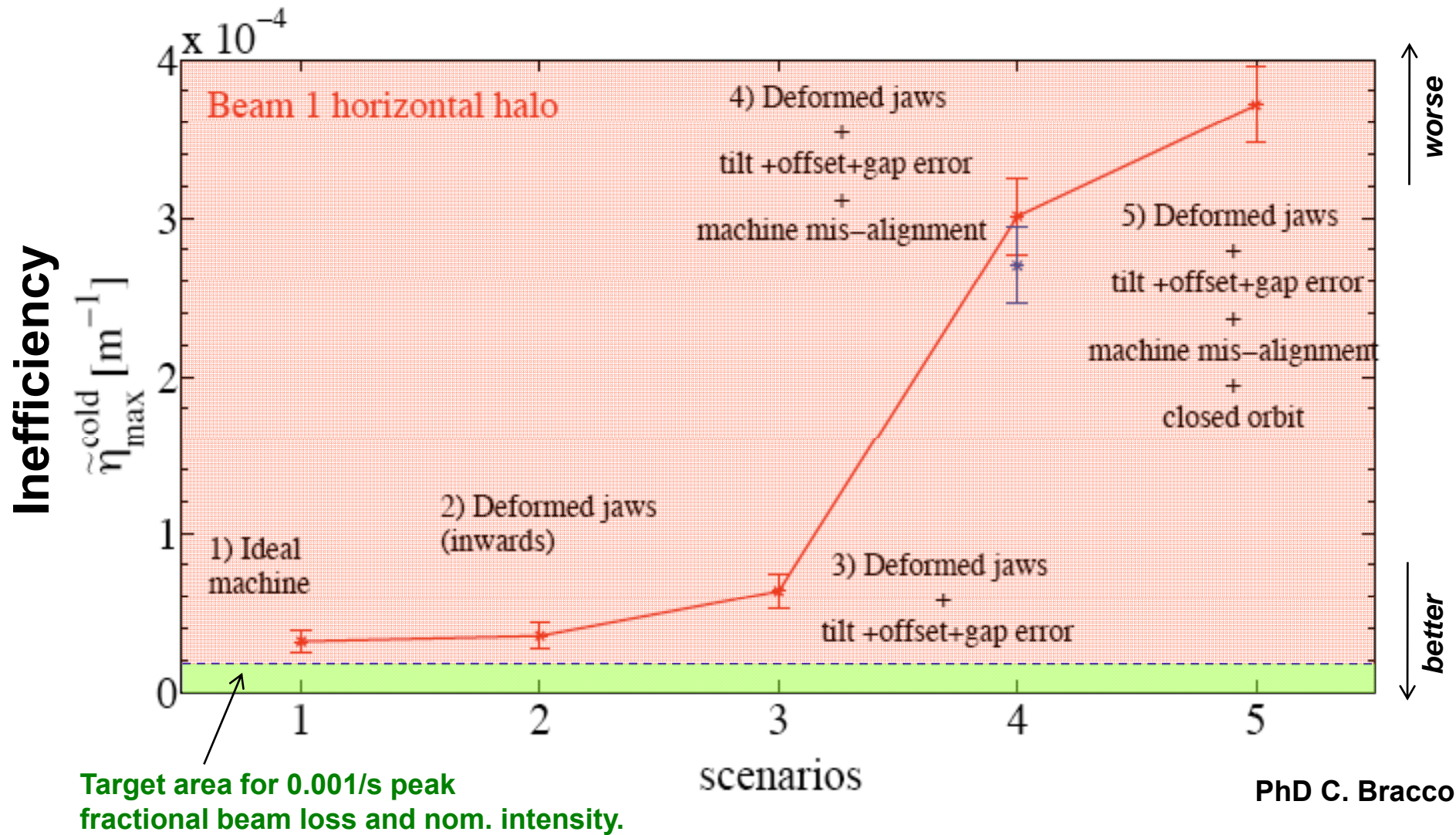

PhD C. Bracco



# Error: Magnet Alignment Errors



Table 6.11: Horizontal and vertical r.m.s magnet misalignments at beam screen level for different families of machine elements. The numbers are based on design values and measurements performed on surface and in the LHC tunnel [78].

Element type	Description	Design		Measured	
		$\sigma_{\Delta x}$ [mm]	$\sigma_{\Delta y}$ [mm]	$\sigma_{\Delta x}$ [mm]	$\sigma_{\Delta y}$ [mm]
MB	main dipole	2.40	1.56	1.83	1.10
MQ	arc quadrupole	2.00	1.20	1.36	0.76
MQX	triplet quadrupole	1.00	1.00	1.53	1.53
MQWA	warm quadrupole	2.00	1.20	0.67	0.41
MQWB	warm quadrupole	2.00	1.20	0.67	0.41
MBW	warm dipole	1.50	1.50	1.96	1.49
BPM	beam position monitor	0.50	0.50	1.36	0.76

PhD C. Bracco



# Impact of Alignment Errors on Inefficiency (Leakage Rate)

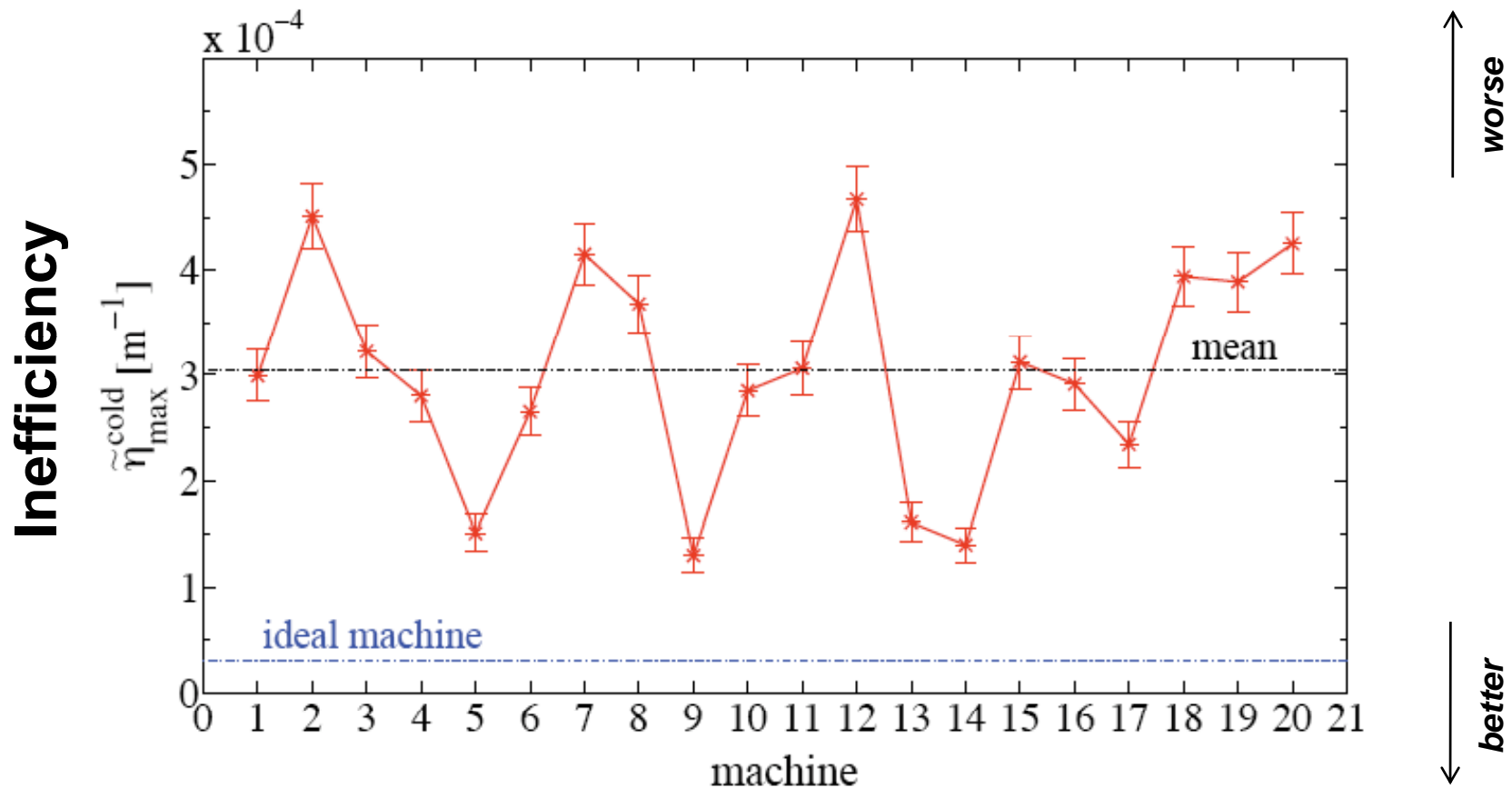

Predicted inefficiency over 20 different seeds of magnet alignment errors. Always worse than ideal, as expected!

PhD C. Bracco





# Proton Losses in Dispersion Suppressor Downstream IR7

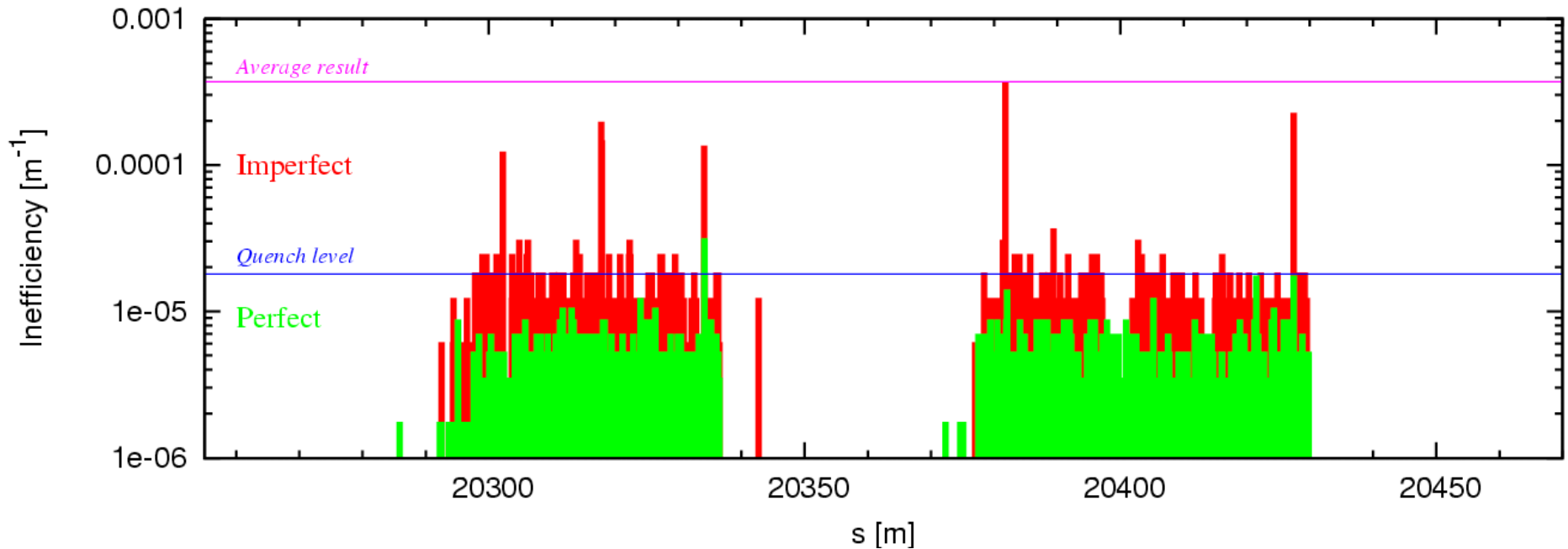
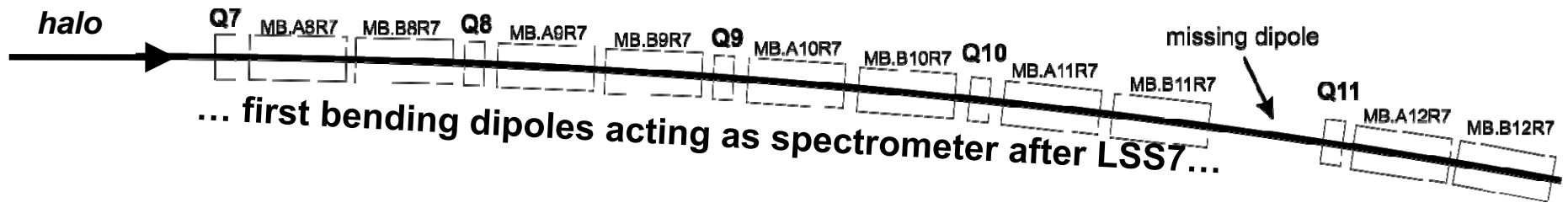

Collisions p on carbon generate off-momentum protons (mostly single-diffractive scattering). Are kicked out by the first bending dipoles (classical spectrometer).



# Ion Losses in Dispersion Suppressor Downstream IR7





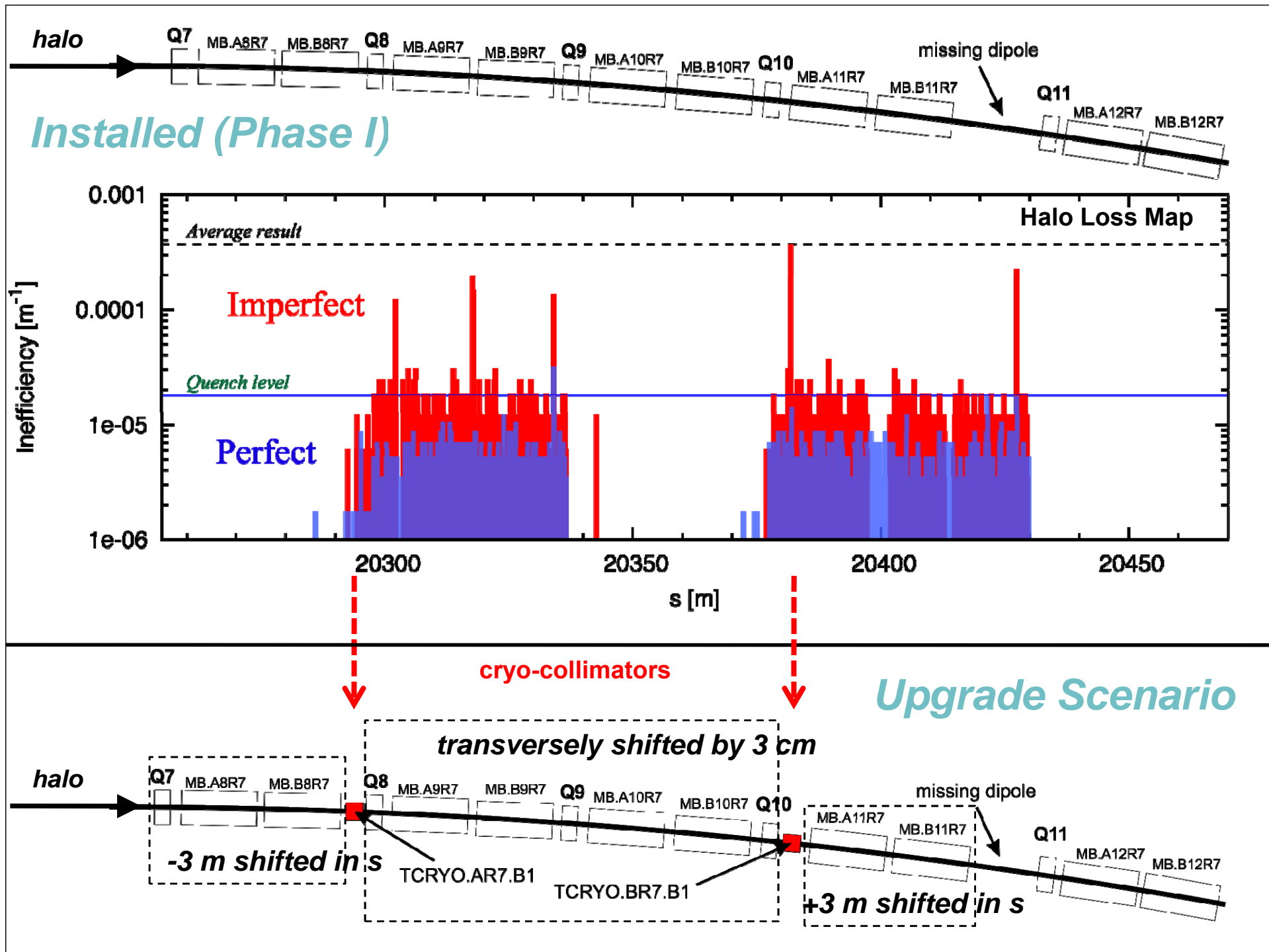

**99.997 %/m → 99.99992 %/m**

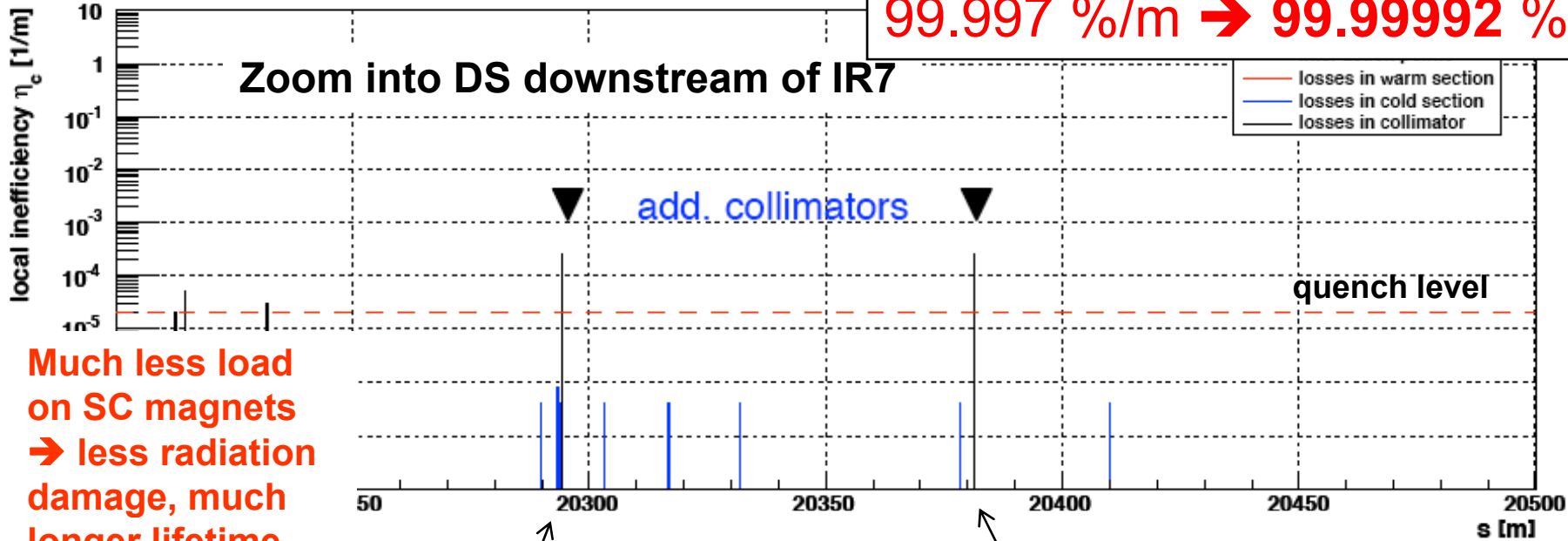

**Much less load on SC magnets → less radiation damage, much longer lifetime.**

*T. Weiler*

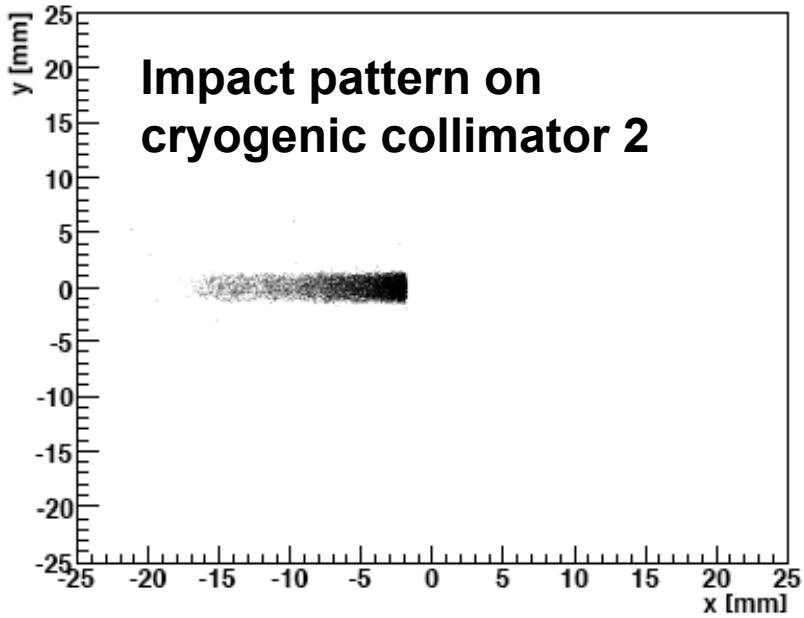
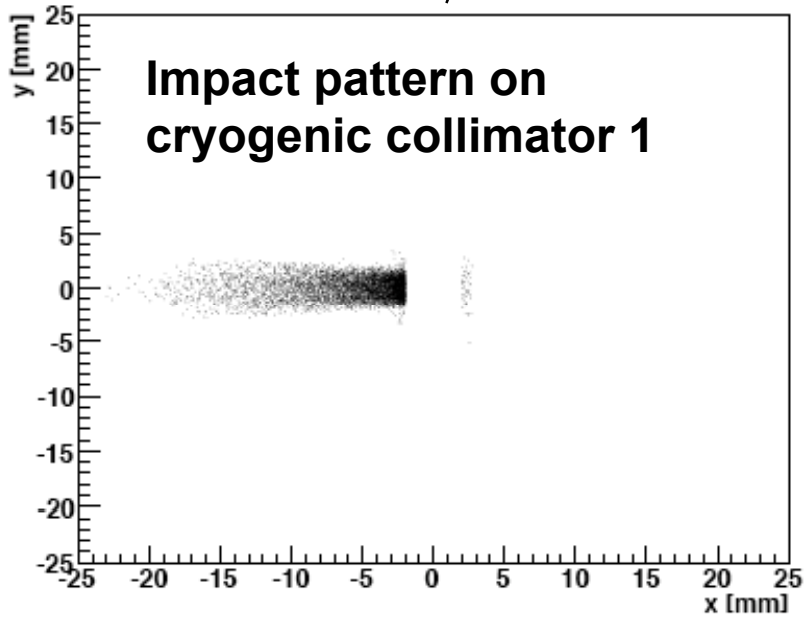

**→ FLUKA studies ongoing to define energy deposition!**





# Remarks Cryo-Collimators



- Strictly speaking we mean **collimators in the cryogenic region** just after the long straight sections.
- These cryo-collimators **can be warm elements** (requiring cold-warm transitions) **or cryogenic elements**.
- Term comes from GSI, as designed for the FAIR project. They use collimators at about 50 K.
- Technical choice must be outcome **of detailed technical design** work.
- **FLUKA studies** ongoing to define best length and material.
- For our studies: **Cryo-collimator = 1 m long copper block**

# Cryogenic FAIR Collimator (GSI)

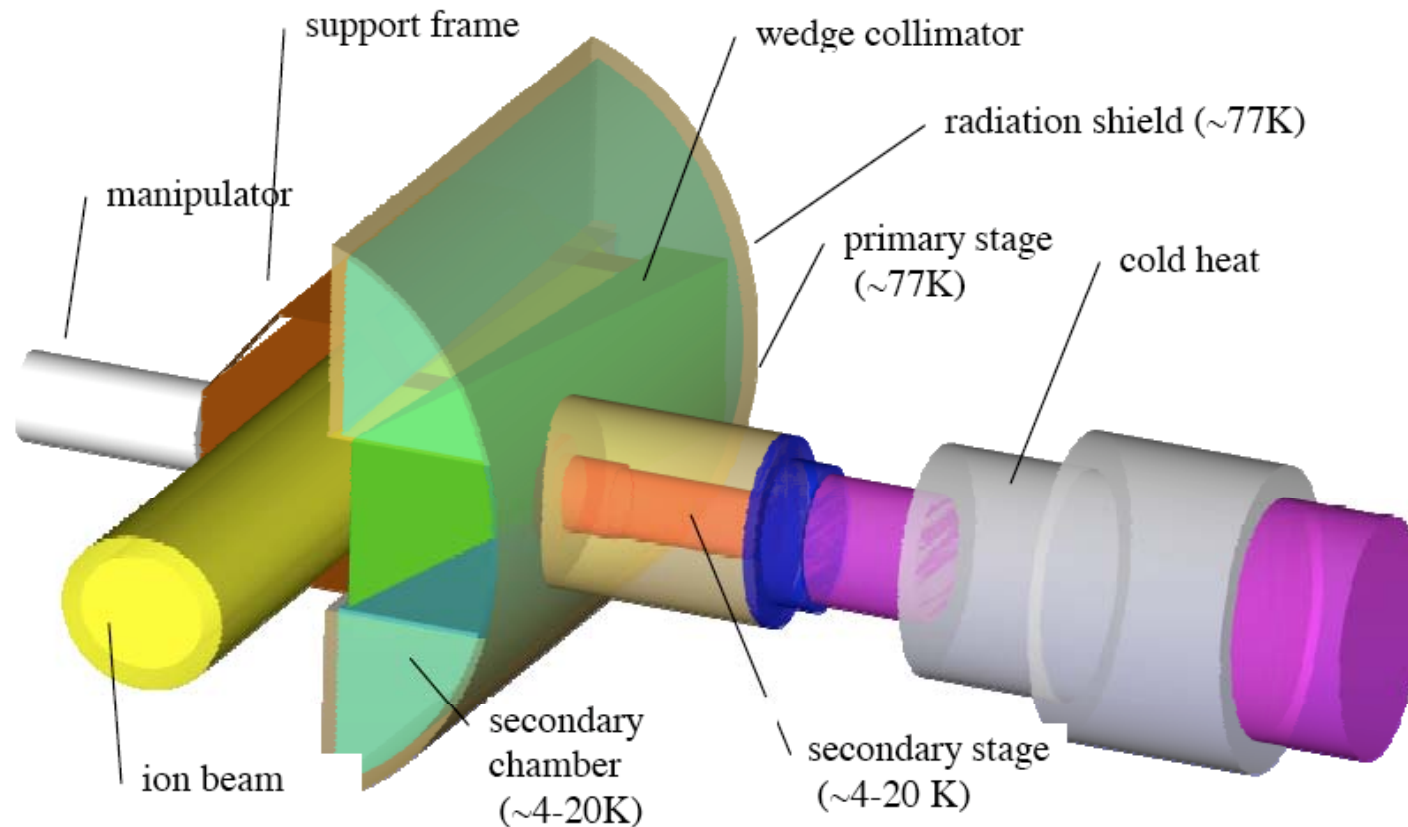

**FIGURE 2:** Proposed collimator for SIS18 with ion beam, support frame and secondary chamber/heat shield.

P. Spiller, K. Blasche, B. Franczak, J. Stadlmann, and C. Omet





# FLUKA Results





# Ion Result with Cryo-Collimators





preliminary

# Load on Experiments



IR	Phase I (perfect)	Phase I (imperfect)	Phase II
IR1	$4.9 \times 10^{-4}$	$1.0 \times 10^{-3}$	$7.7 \times 10^{-6}$
IR2	$1.3 \times 10^{-4}$	$2.1 \times 10^{-4}$	$2.2 \times 10^{-6}$
IR5	$6.5 \times 10^{-6}$	$5.7 \times 10^{-5}$	$2.9 \times 10^{-6}$
IR8	$3.0 \times 10^{-4}$	$7.5 \times 10^{-4}$	$5.6 \times 10^{-5}$

- Numbers show **fraction of overall loss that is intercepted at horizontal tertiary collimators** in the various insertions (collimation halo load).
- Phase 2 collimation upgrade **reduces losses in IR's by a factor up to 60!**
- Beam 2 has opposite direction → more losses in IR5 and less in IR1!





## Issue 2: Impedance

- The phase I primary and secondary collimators place **fiber-reinforced carbon** close to the LHC beam.
- **Small gaps** are required for good protection and cleaning efficiency.
- **Collimators produce most of the impedance in the LHC** up to the point that beam instabilities are predicted, even with fully powered octupoles.
- **Impedance intensity limit: ~40% with collimators**
- Several solutions considered:
  - **Advanced materials**, make use of bypass effect with ceramics, ... No magic bullet yet even though improvements predicted.
  - **Standard metallic materials** (e.g. Cu) with good electrical conductivity. Only slight improvement.
  - Use of **transverse feedback** to optimize beam. Looks hopeful.
  - **Open collimator gaps** if cleaning efficiency allows to do so.



# Impedance Phase I

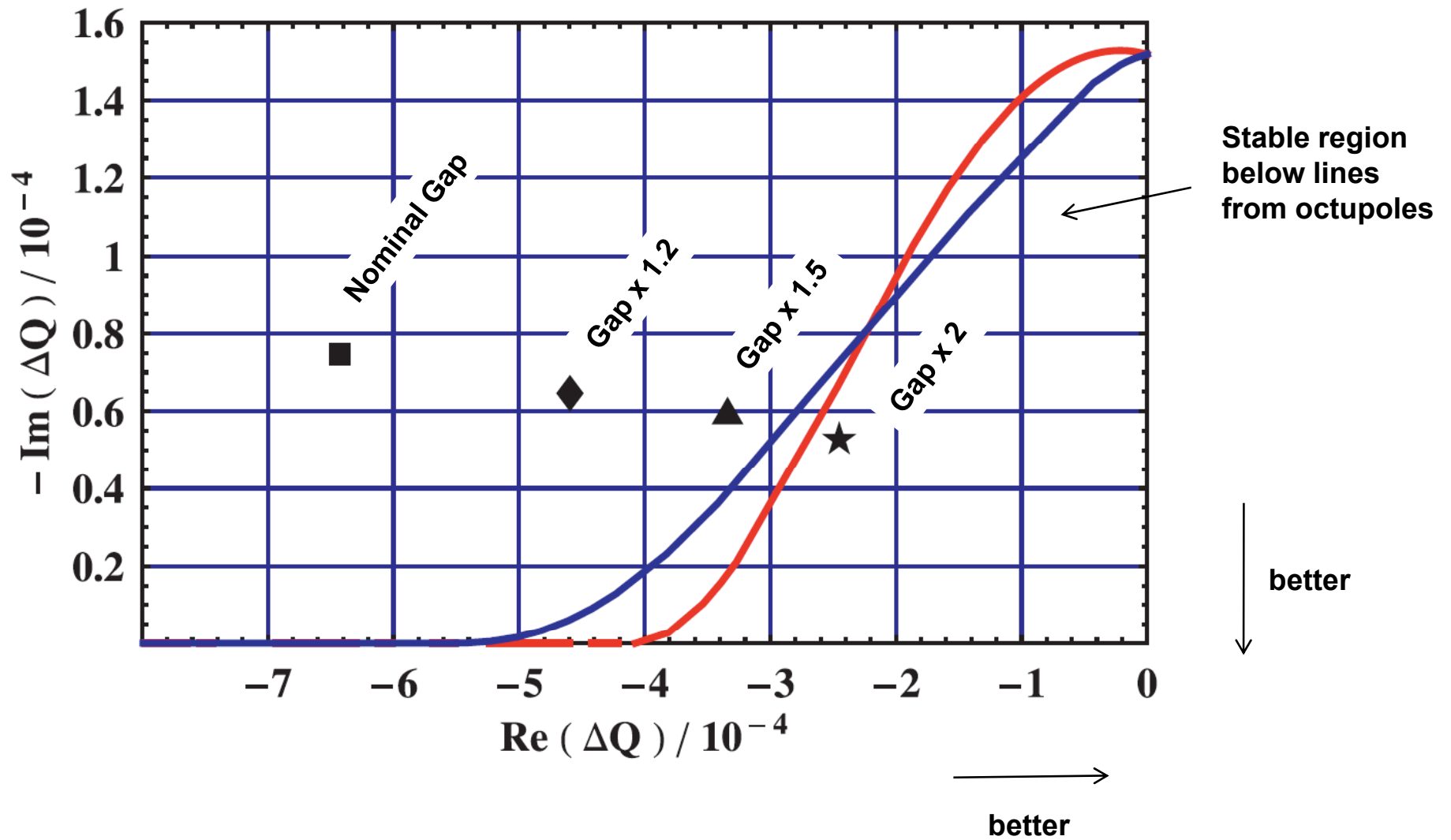



# Phase I: Tradeoff $\rho$ Inefficiency - Impedance

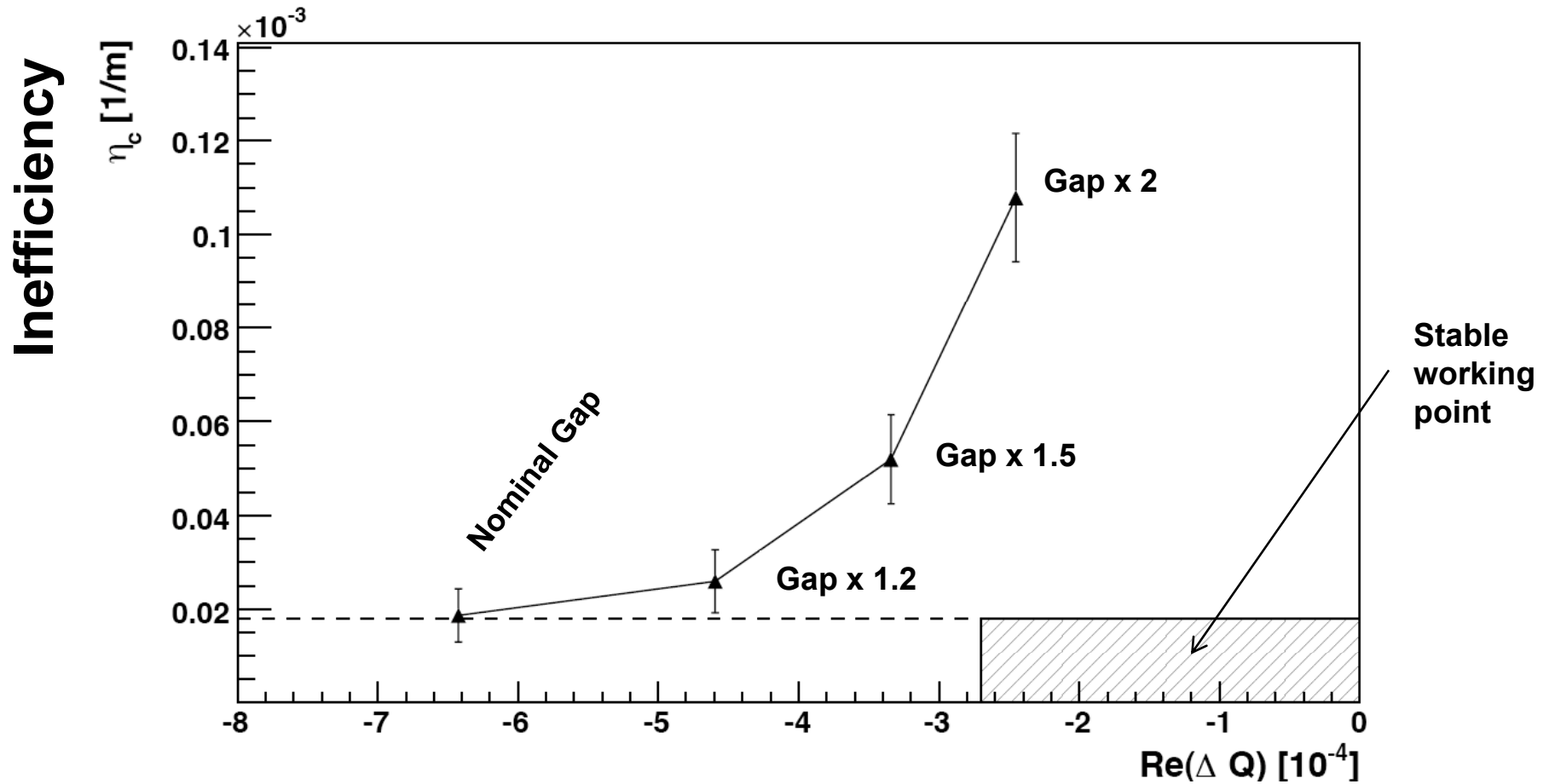

**No solution for phase I, except feedback!**

**Impedance**



- Preliminary tests of UHV compatibility
  - Two samples of Cu-D and Al-D proposed by L. Weber at EPFL.
    - Ready available, irregular shape
  - Outgassing tests made by I. Wevers
    - Cu-D:  $2 \times 10^{-12}$  torr·l·s<sup>-1</sup>·cm<sup>-2</sup>
    - Al-D:  $10^{-11}$  torr·l·s<sup>-1</sup>·cm<sup>-2</sup>
    - Preliminary results **compatible with standard UHV** use
- Further steps
  - Functionally interesting?
  - Study feasibility of required dimensions
  - Tests foreseen
    - Thick coating for machining
    - Brazing to ceramics and to copper
    - Radiation effect on properties
    - Other...
- For the moment assume simple Cu...

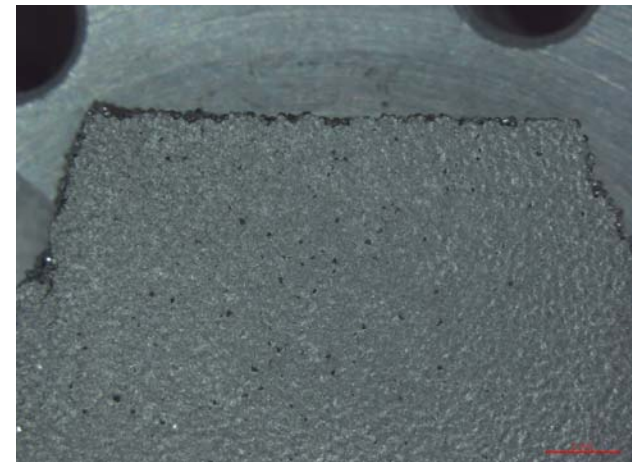
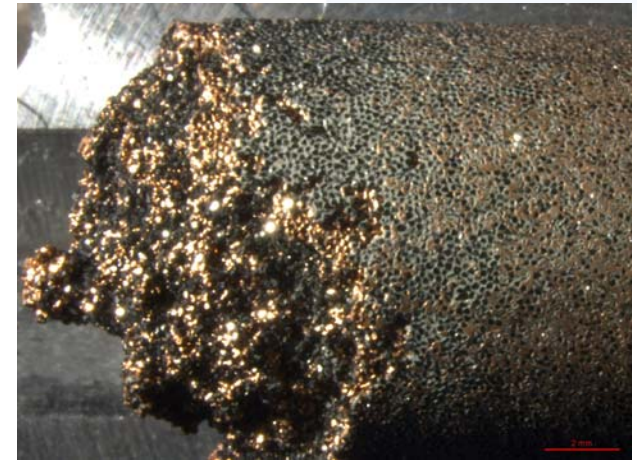

G. Arnau Izquierdo  
CERN

5mm

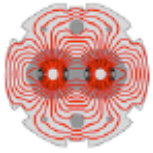

LARP

# US LHC Accelerator Research Program



BNL - FNAL - LBNL - SLAC

## LARP Phase Engineering

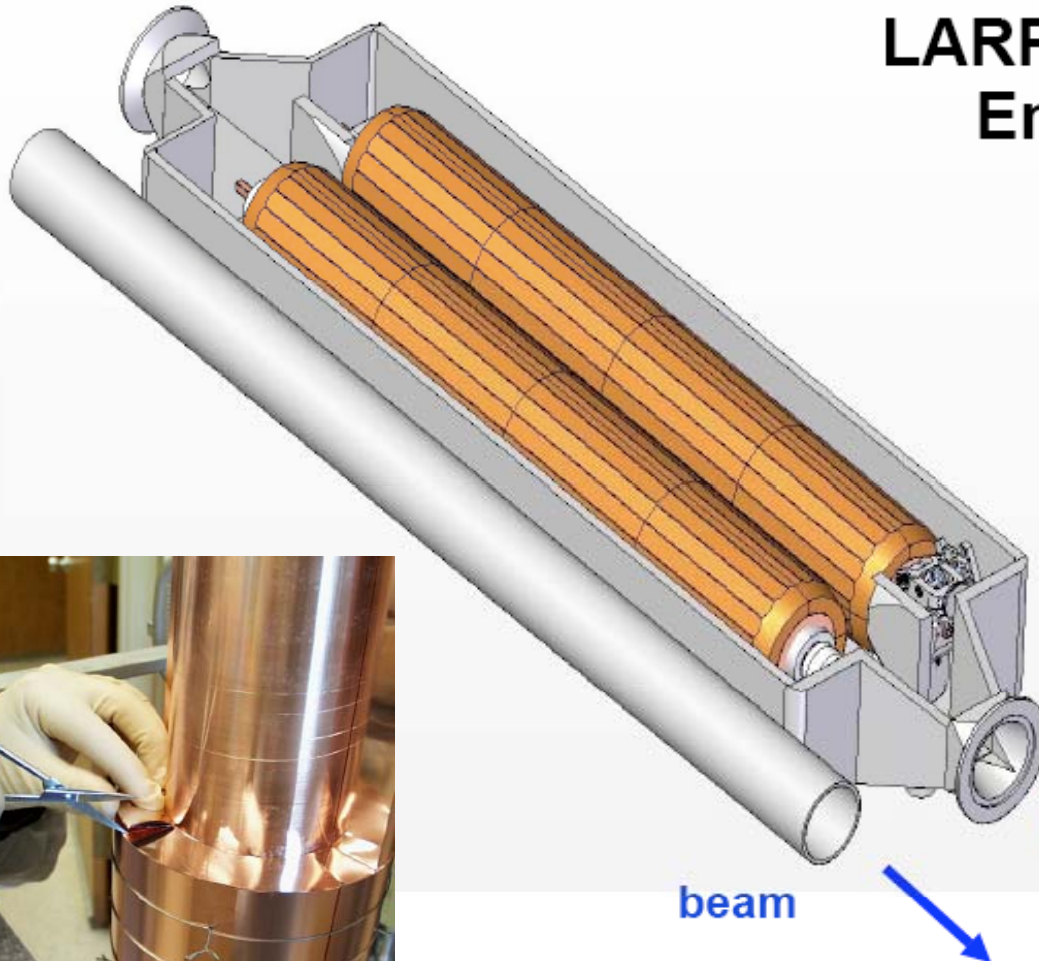

Jeff S  
SLAC



Eric Doyle, Lew Keller, Steve Lundgren, Tom Markiewicz, Reggie Rogers & Jeff Smith



# Phase II Secondary Collimators (Cu)

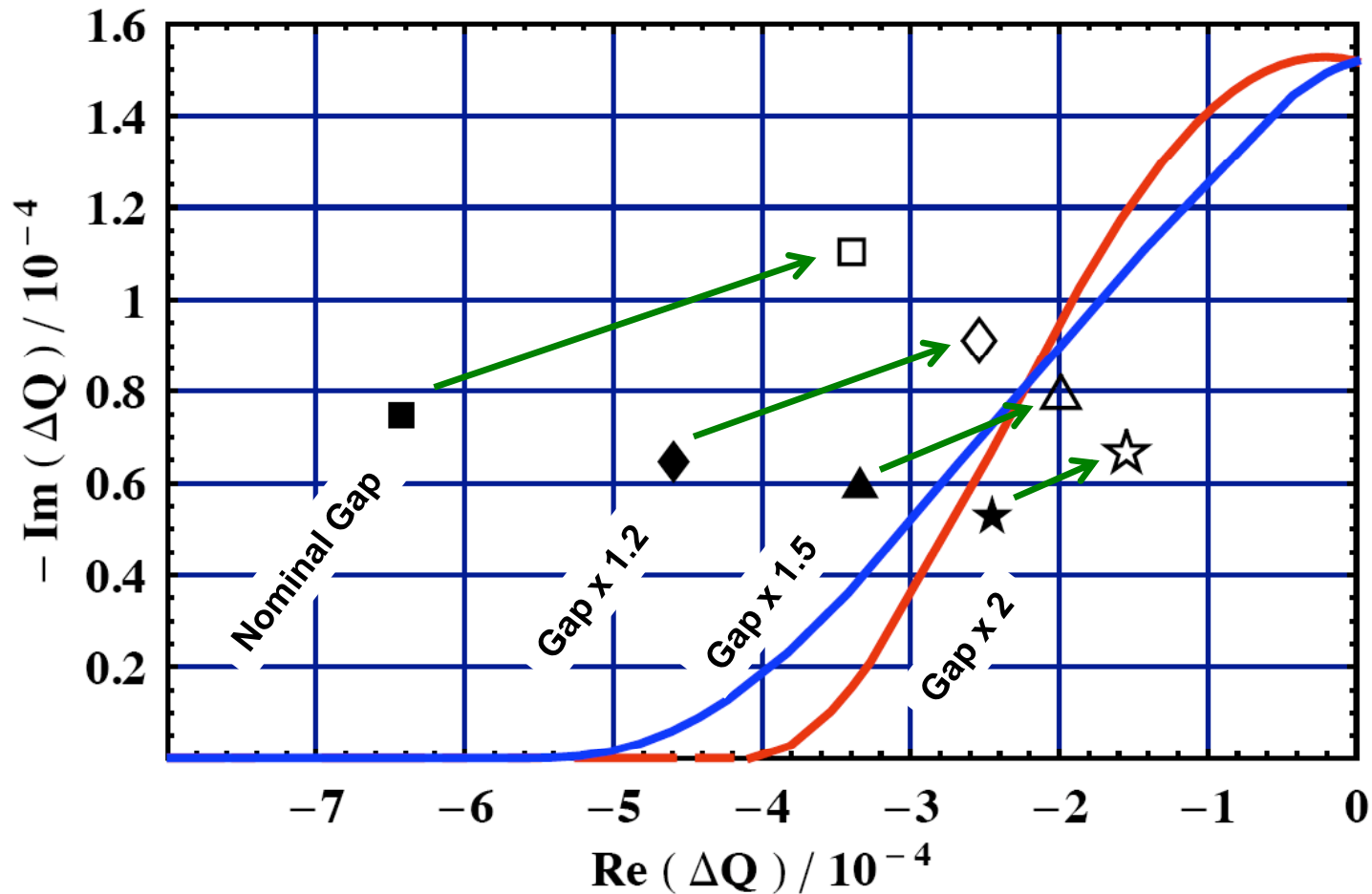

**Metallic Cu secondary collimators (phase II) require less gap opening for stability!**





# Phase II: Tradeoff p Inefficiency - Impedance

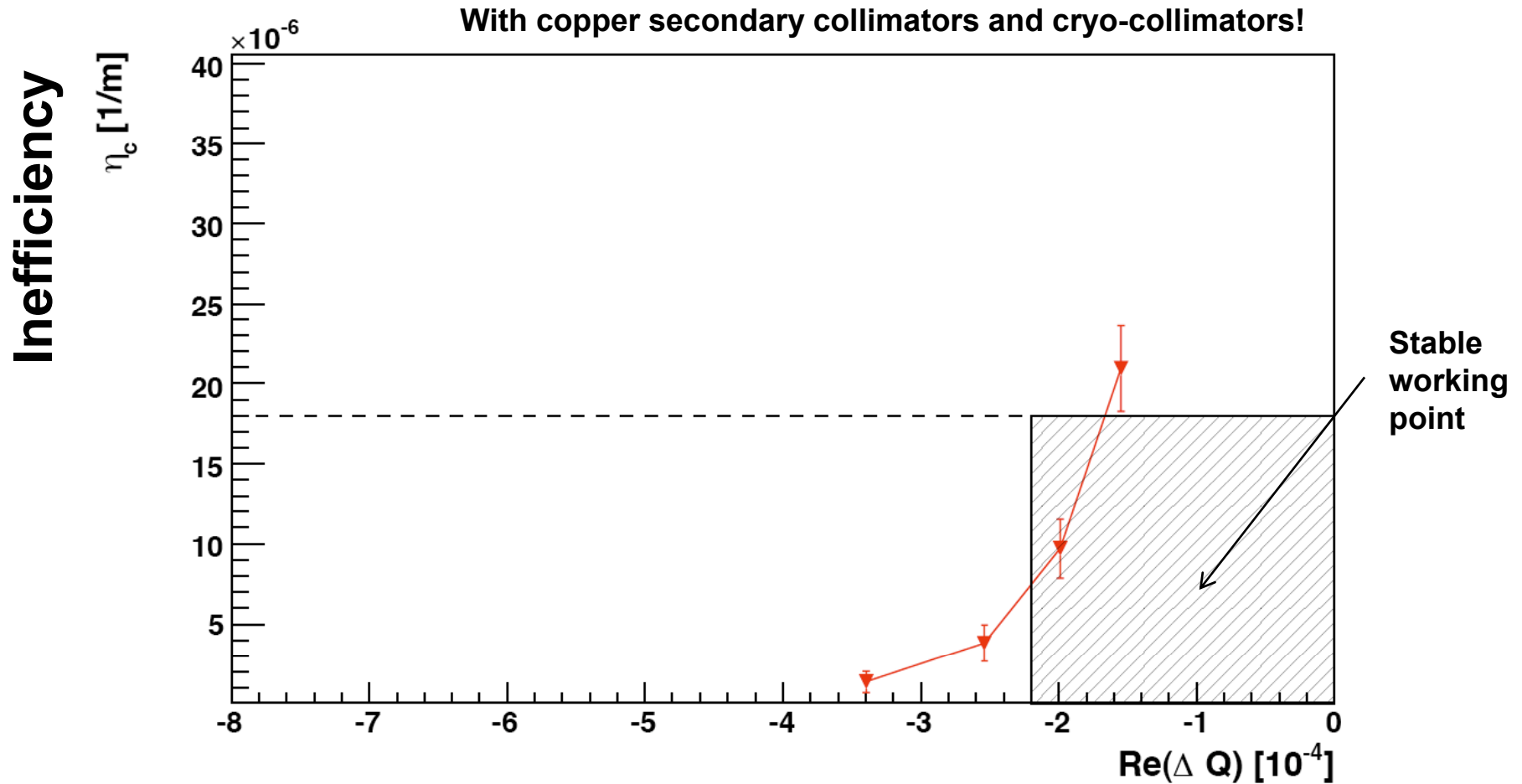

**Phase II allows stable working point by opening gaps! Imperfections to be included!**

**Impedance**



# Issue 3: Operational Efficiency



- Standard method of collimator setup relies on **centering collimator jaws by creating beam loss** (touching primary beam halo with all jaws).
- Procedure is lengthy (48h per ring?) and **can only be performed with special low intensity fills for the LHC.**
- Big worries about risks, reproducibility, systematic effects and time lost for physics (integrated luminosity).
- Tevatron and RHIC must rely on collimator calibration and optimization performed **at the start of each physics run.**
- LHC can only do better if **non-invasive methods** are used (no touching of primary beam halo and no losses generated): **integration of pick-ups** into jaws.

# Schematic 1

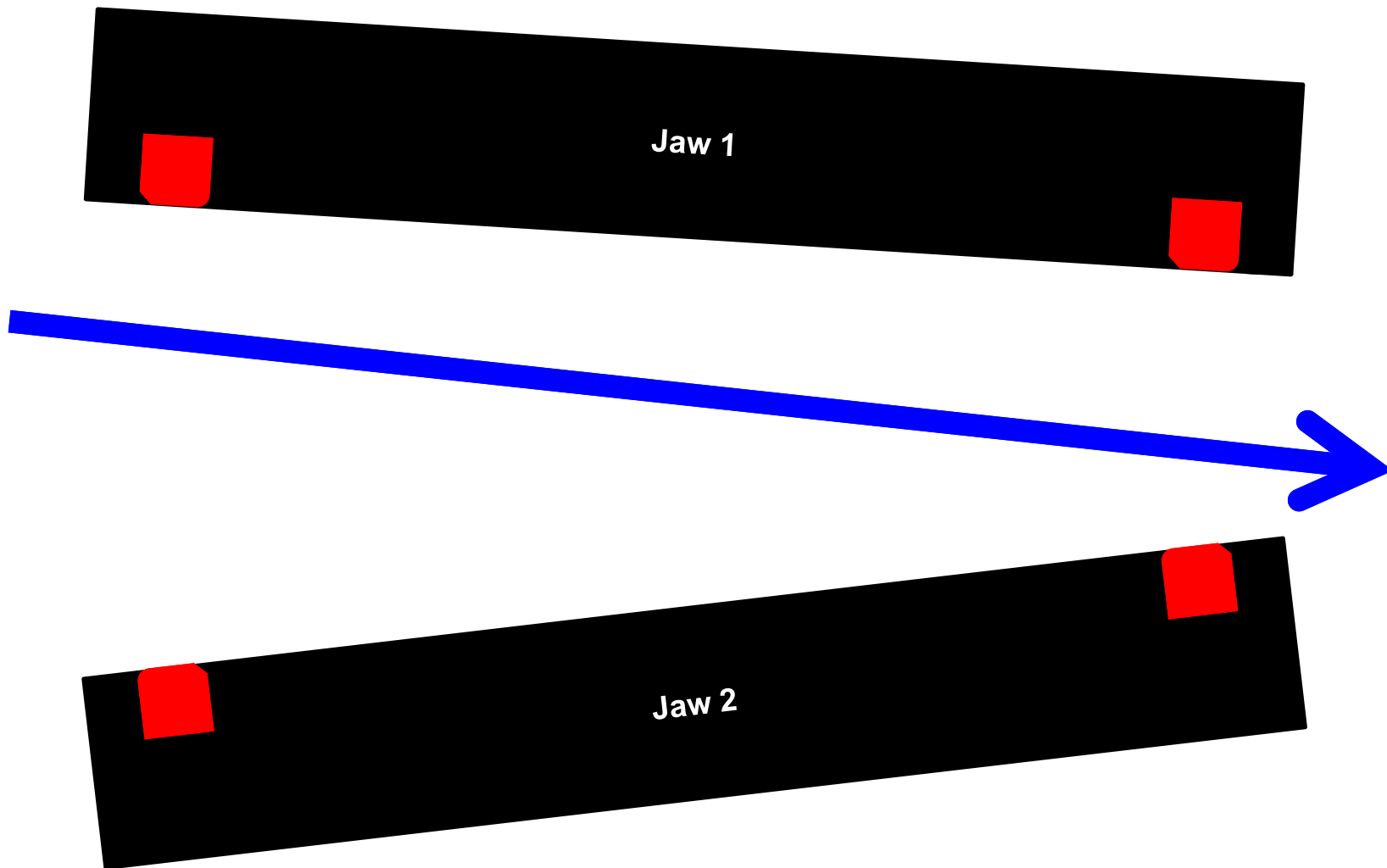



# Schematic 2

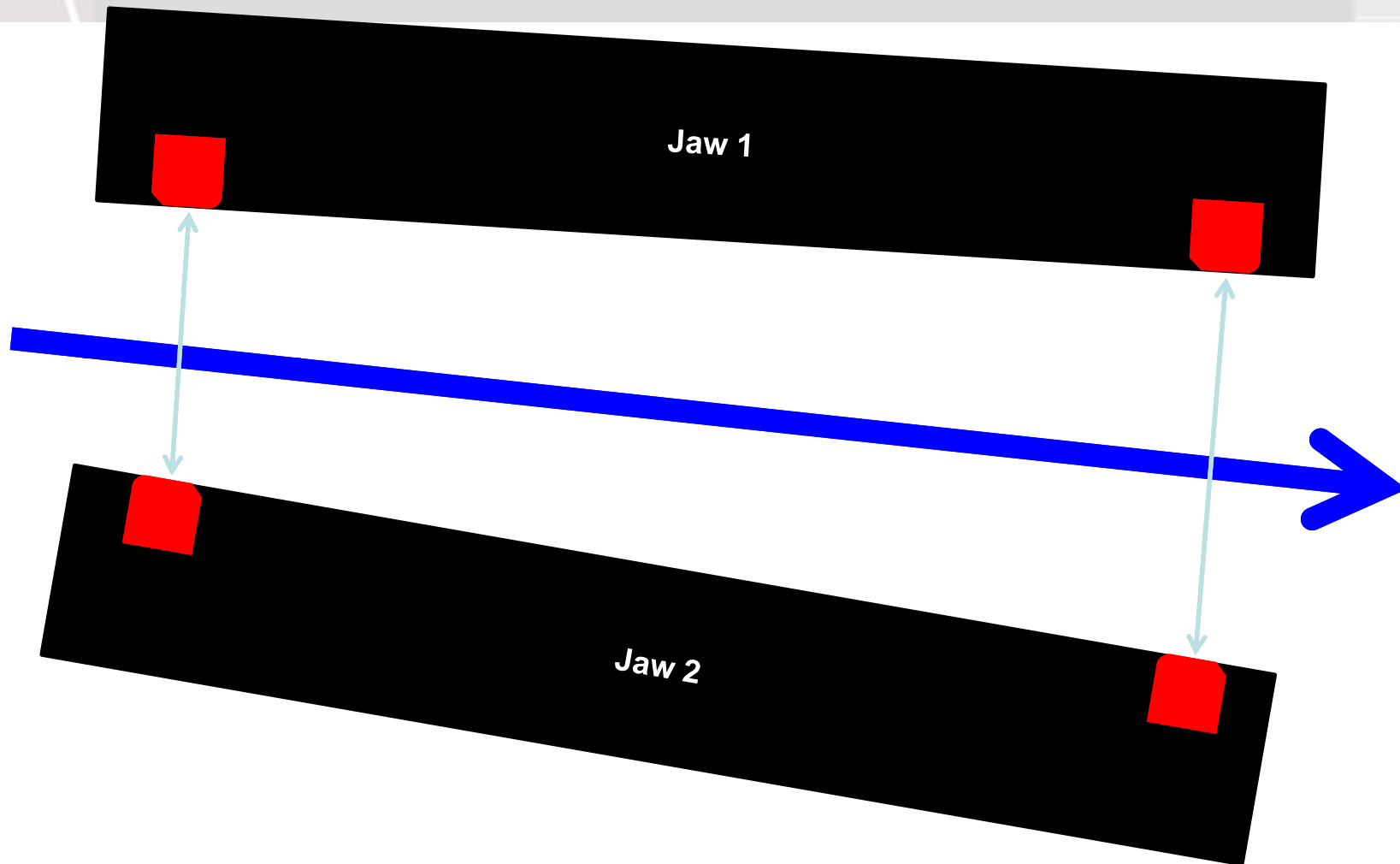

**1) Center jaw ends around beam by zeroing difference signal from pair of pickups.**

# Schematic 3

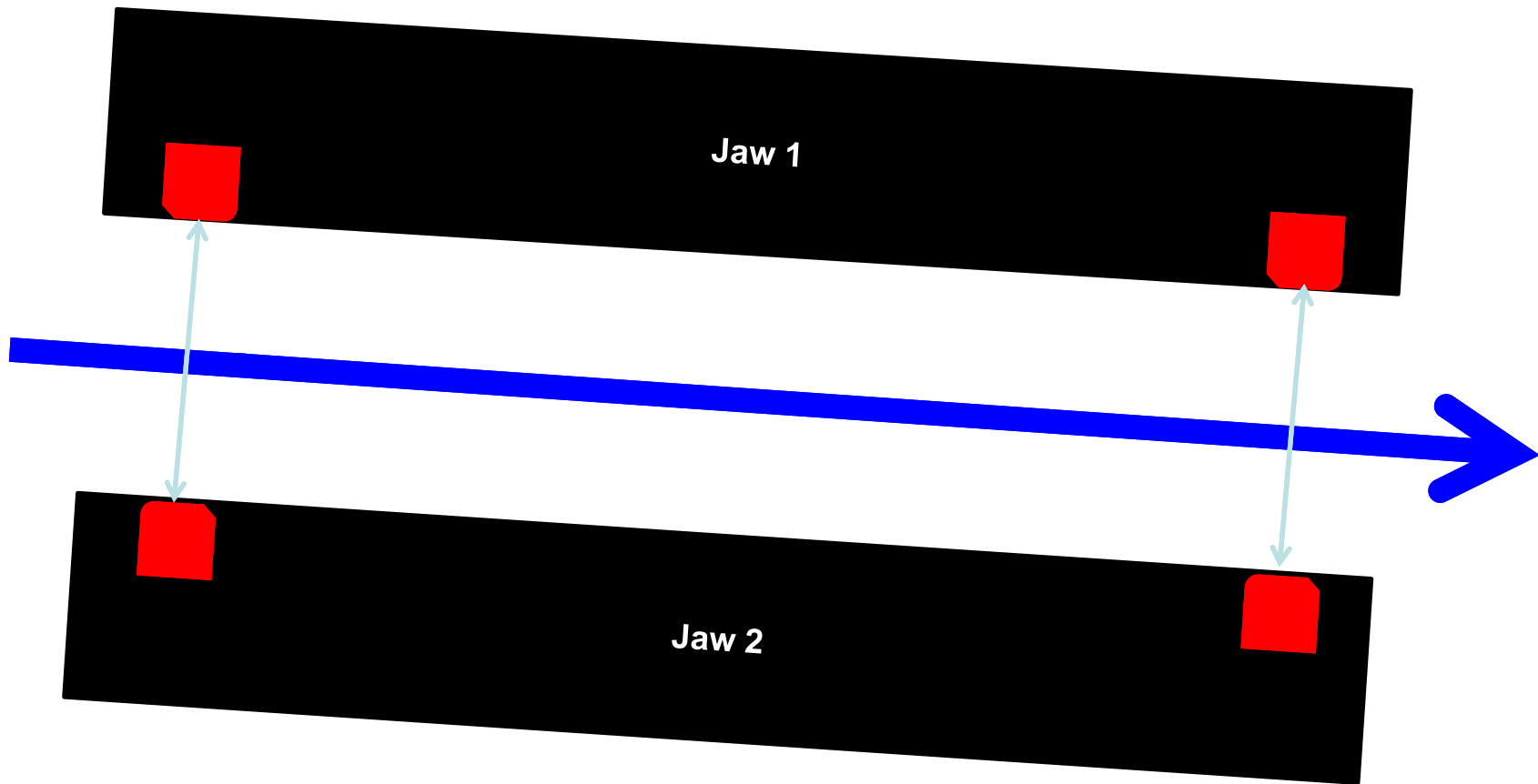

2) Put the same gap at both ends as measured from jaw position (phase 1 feature).

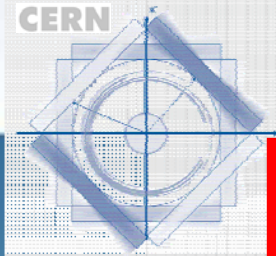

# BPM integration

Integration of BPMs into the jaw assembly gives a clear advantage for set-up time → Prototyping started at CERN

**BPM pick-ups**

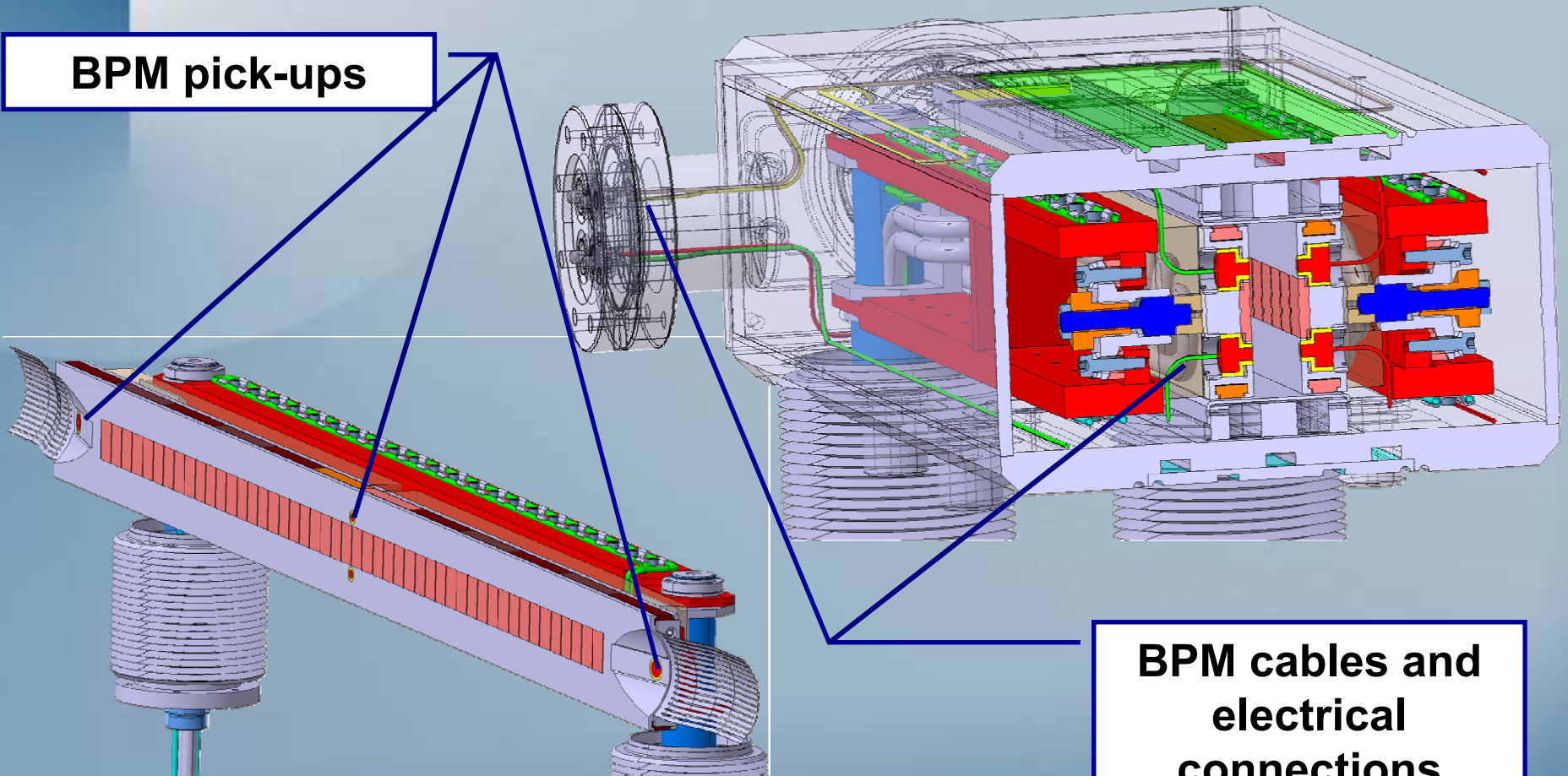

**BPM cables and electrical connections**

R. Assmann, CERN





# Issue 4: Loss Rates



- **Beam tails** develop during operation and **extend up to the boundary** defined by the primary collimator walls.
- Any small “**shaking**” of the beam will induce a small beam loss, often modulated by the synchrotron tune (no smooth loss rate as assumed for the LHC). Often significant losses when bringing beams into collision.
- **Spiky behavior of beam loss and background worsens situation for beam cleaning.**
- Standard technique: **Scraping (removal) of beam tails after/during the energy ramp and squeeze** to avoid this effect (Tevatron, RHIC).
- Impossible for the LHC due to high power beams (**no scraping below 5 sigma**). No scrapers have been built.
- Solution: **Use e-beam lens, used routinely as scraper in Tevatron. Adapt to provide hollow lens!**



# The Tevatron e-Beam Lens





# Issue 5: Radiation Damage



- Robustness of primary and secondary collimators at the LHC relies on the low Z fiber-reinforced graphite:
  - The **collimator jaws themselves will be ageing from radiation damage**. Increase in electrical resistivity, decrease in mechanical strength, radiation swelling, ...
  - The **warm magnets downstream will have a limited lifetime**, even after adding various passive absorbers and protection masks.
- Higher Z secondary collimators with Cu jaws used in stable physics:
  - **Higher radiation robustness.**
  - **Higher absorption.**
  - **Less radiation leakage and longer lifetime of warm magnets.**





# Experimental and Theoretical Studies on Radiation Damage in Materials (p & ion)



**Analysis of Radiation Induced Erosion  
Material AC Irradiated by Carbon Ions  
at Irradiation Dose:  $1 \times 10^{16}$**

Research topic:  
**Radiation damage in  
accelerator materials**

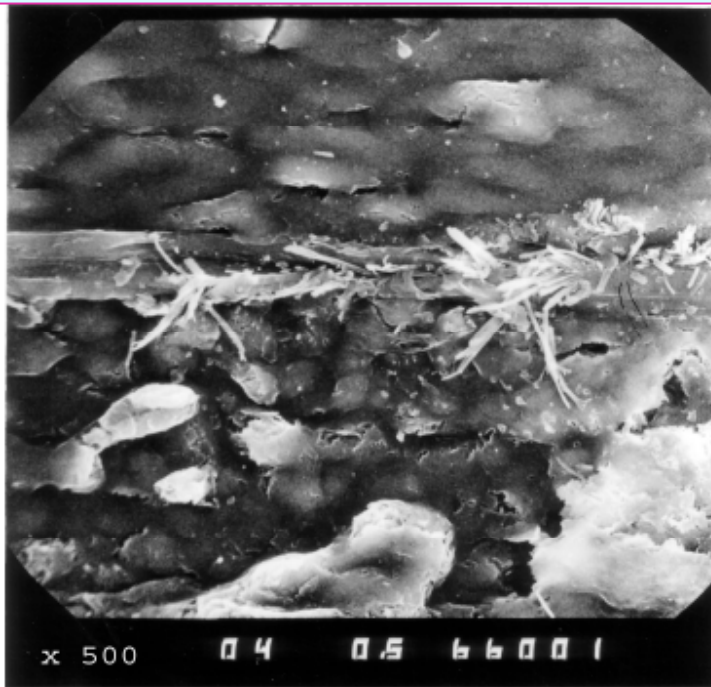

A. Ryazanov

→ Working on understanding radiation damage to LHC collimators from  $10^{16}$  impacting protons of 7 TeV per year. Also with BNL/LARP...

... in addition shock wave models...



# Radiation Damage Measurement

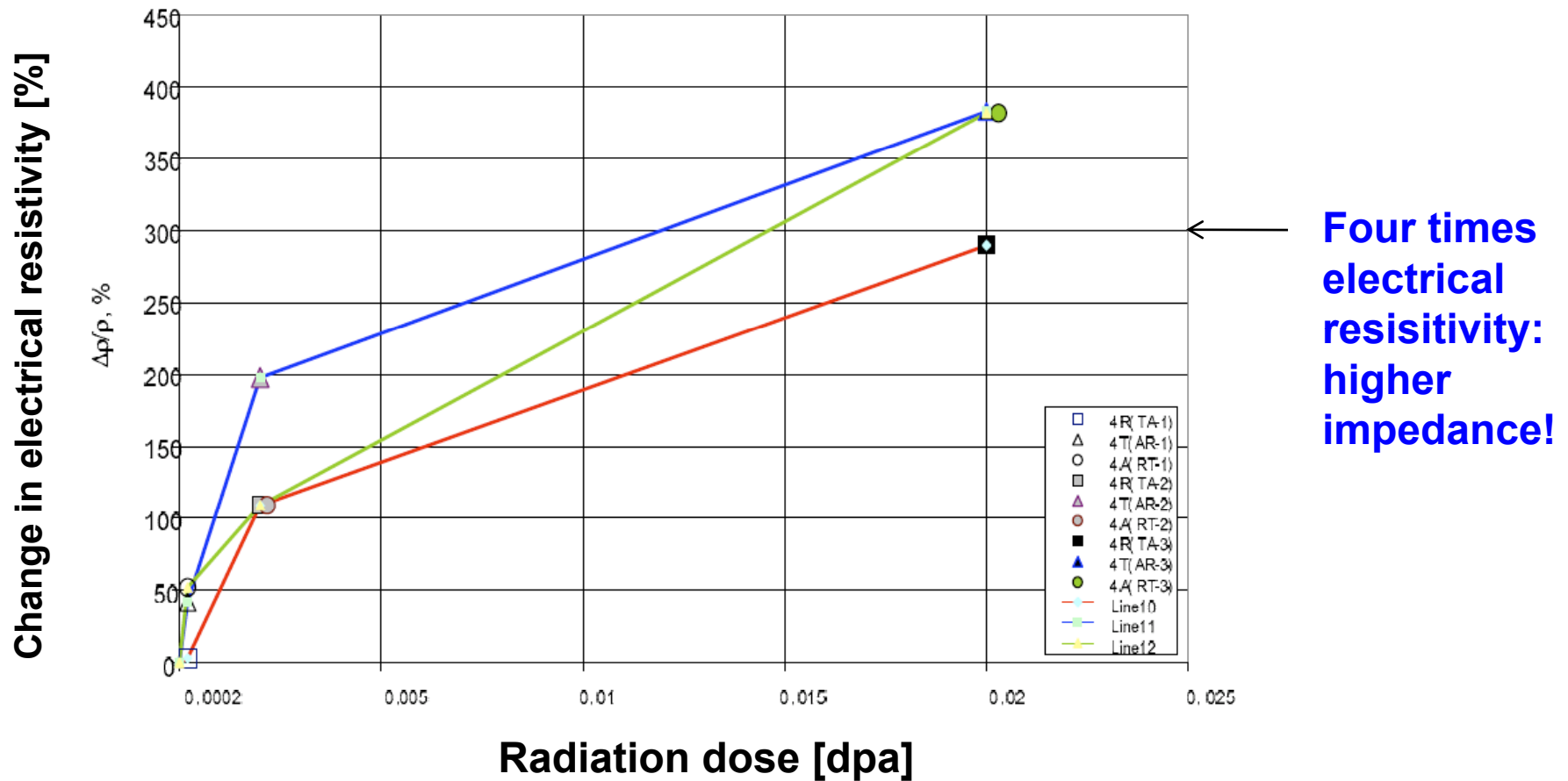

Collimator properties will change with time → many properties checked.  
Beneficial to distribute radiation over phase I and phase II collimators!



# Test Needs: HiRadMat



- Phase I was putting robustness first.
- Phase II considers using less robust collimators in stable physics.
- Assumptions:
  - Rare damaging events.
  - Benign damage in case of hit.
- Risk of non-benign risk must be assessed before installation of such collimators.
- Requires beam test area **HiRadMat**. 2 MJ pulsed beam at ~450 GeV from SPS for accident scenario test.



# Specification for a Test Facility with High Power LHC Type Beam

**R. Assmann, A. Bertarelli, I. Efthymiopoulos, B. Goddard,  
C. Hessler, T. Markiewicz<sup>1</sup>, M. Meddahi, R. Schmidt,  
J. Sheppard<sup>1</sup>, H. Vincke**

## Abstract

The characteristics of the LHC beam mean that the energy deposited in the event of interaction with accelerator components can be much above the damage thresholds of materials. This report specifies a test facility with high intensity LHC-type beam, as included in the framework of the “phase 2 LHC collimation project” and the “EUCARD proposal to FP7”. The specified facility is required to test accelerator components and materials for sufficient robustness with beam shock impact, prior to installation into the LHC or its injectors. A 7  $\mu$ s long pulse can be extracted about every 30 seconds and delivered into a small transverse area (controllable around 1 mm<sup>2</sup>), carrying an energy of up to 2 MJ. The corresponding pulsed peak power is 340 GW for protons and 2.3 GW for lead ions. The facility will also provide opportunity for reproducing and analyzing any possible primary and secondary effects from beam-induced damage encountered during LHC operation.



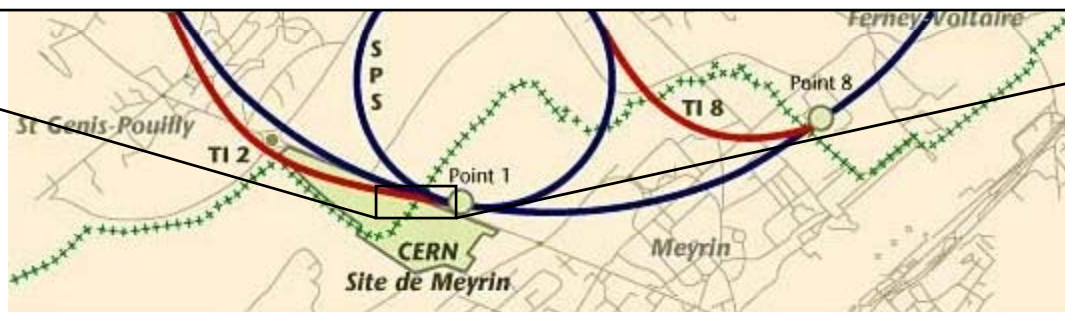
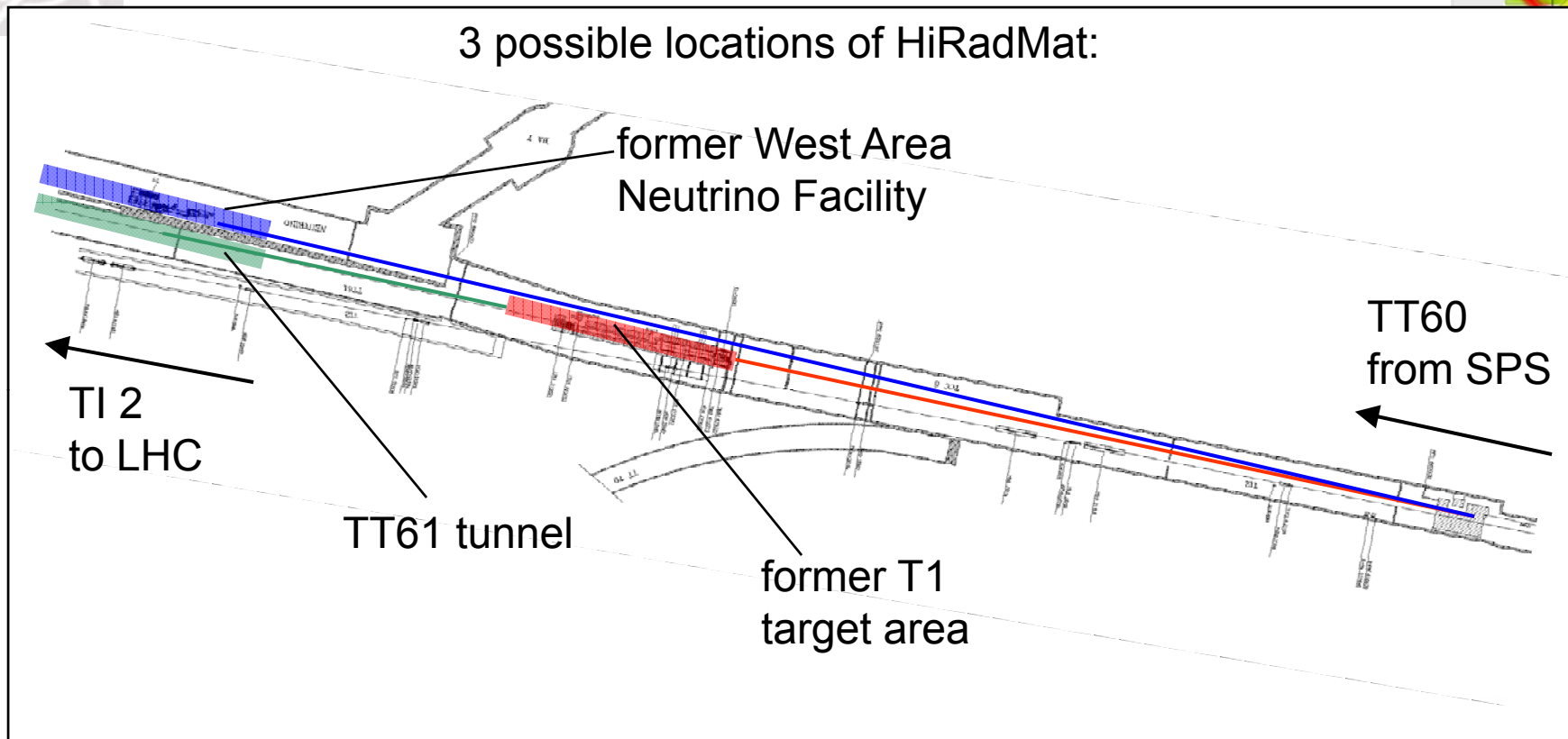

C. Hessler



# Work Plan



- The following work has been worked out to ensure fastest possible readiness for LHC nominal and ultimate beam intensities:
  - Continue R&D on [low impedance materials](#) for LHC collimators. → CERN, FP7.
  - Continue design, prototyping and testing of [phase II secondary collimators](#), implementing in-jaw pick-ups (improved operation) and various jaw materials (lower impedance). Construct 30 plus spares. → CERN/FP7, SLAC/LARP.
  - Install [HiRadMat facility](#) for beam verification of advanced designs, following conceptual design which we worked out. → CERN, SLAC?.
  - Start R&D, prototyping and testing on [hollow e-beam lens](#) for LHC scraping. → FNAL, CERN.
  - Work out technical design for [modified dispersion suppressors](#) in IR3/7. Design and build new cryostat for missing dipole. → CERN.
  - Start R&D on “[cryo-collimators](#)” for modified dispersion suppressors.



# Work Packages A



WP1 Modifications SC dispersion suppressor (CERN)

WP2 Collimator for cryogenic region (CERN, GSI)

- Benefits: **Gains more than factor 10 for cleaning efficiency.**
  - Fixes problem of losses in SC dispersion suppressor both for ions and p.
  - Improves lifetime of SC magnets.
  - Requires no civil engineering nor new SC magnets.
  - Less sensitivity to imperfections.
- Difficulty: **Requires modification of SC regions around IR3 and IR7.**
- Risks: None.
- Beam experience: **Not required**, even LEP2 collimation had this function.
- Timeline: New work but help from FP7 (GSI/FAIR). Can start immediately. Install 2011/12? Ready for 2012 run if priority is put?



# Work Packages B



WP3 Advanced Secondary Collimators (CERN, LARP/SLAC, FP7-ColMat)

WP4 HiRadMat Test Area (CERN, SLAC, FP7)

- Benefits: **Improved operational efficiency, impedance, lifetime.**
  - Provides possibility to set up collimators at high intensity, as Tevatron.
  - Improves operational efficiency with faster collimator setup.
  - Reduces impedance. Reduces tertiary halo.
  - Improves lifetime for warm magnets and secondary collimators.
- Difficulty: Potential damage with accidents (asynchr. beam dump).
- Risks: **Damage in the LHC** from unexpected features.
- Beam experience: **Required.** Both tests in test area (shock) and LHC.
- Timeline: Started. Tests in HiRadMat in 2011? Tests in LHC 2012? Produce 2013? Install 2013/14? Ready for 2014 run if no further delays?





# Work Packages C



## WP5 Hollow e-Beam Lens Scraper (FNAL, CERN).

- Benefits: **Active halo control and reduced peak loss rate.**
  - Provides possibility to actively control and remove halo by scraping, like in Tevatron.
  - Reduces peak loss rates (spikes in beam loss).
- Difficulty: **Effectiveness of hollow region.**
- Risks: Due to low diffusion speed, none for the machine. Effectiveness of scraping to be assessed.
- Beam experience: **Required.** Both tests in SPS and LHC useful.
- Timeline: New work but FNAL interested. Tests in SPS in 2011? Tests in LHC 2012? Ready for operational use in 2012 or in 2013?



# Work Packages D



## WP6 Experiments (CERN)

- Benefits: **Address issues and lessons in experimental regions.**
  - Fix ion luminosity limit in IR2, possibly IR1 and IR5.
  - Optimize simultaneous protection and signal acceptance issues in various IR's.
- Difficulty: None.
- Risks: None.
- Beam experience: **Required** to know all issues.
- Timeline: After first beam experience.



# Suggested Milestones I



- 2009 **Review conceptual design**, go ahead, refined WP's.  
Start WP's cryogenic collimation and hollow e-beam lens.  
Continue other WP's.
- 2010 **SPS:** Beam test of **collimator with in-jaw pick-ups** (presently under construction), if we can install.  
Study results on in-jaw pick-up with Darmstadt/TEMF.  
**LHC:** **Review beam experience with phase I collimation system.**
- 2010/11 **TT60:** **HiRadMat** test facility installation.
- 2011 WP cryogenic collimation completed and hardware constructed.  
**HiRadMat:** Beam tests of **advanced secondary collimators**.  
**HiRadMat:** Material tests with beam shock impact.  
**SPS:** Beam tests of the **hollow e-beam lens** scraping.
- 2011/12 **LHC:** Modify **SC dispersion suppressors** around IR7 and IR3.  
**LHC:** **Install collimators** into the space created.



# Suggested Milestones II



- 2012: **LHC:** Ready for nominal intensity.  
**LHC:** Parasitic beam tests of advanced secondary collimators.  
**LHC:** Parasitic tests of the hollow e-beam lens.  
Construction decision for phase II secondary collimators, decision for materials and concept (taking into account LHC beam experience, e.g. frequency of erroneous beam hits).
- 2013 **LHC:** Reduced beam tails and lower peak loss rate with scraping.  
Construction of phase II secondary collimators.
- 2013/14 **LHC:** Installation of advanced secondary collimators.
- 2014 **LHC:** Collimation with ultra-high efficiency, fast and non-destructive collimator setup and safe halo scraping.





# Reserve Slides





# Uncertainties I



- There are **significant uncertainties** in our predictions.
- **Loss rates in normal operation:**
  - We allow for up to **0.1% of beam lost per second for up to 10 seconds** (0.2 h beam lifetime).
  - Expect these losses during  **$\beta$  squeeze, while bringing beams into collision, beam tuning (tune), ...**
  - Parameter strongly supported by international experts in external collimation review in 2004 (experience from HERA, TEVATRON, RHIC, SSC design, SNS design).
  - Can be better or worse. Judgement depends on the person looking at this.
- **Abnormal losses:**
  - We allow for **up 0.3 % of 7 TeV beam lost on a collimator (single-turn) without damage** (nominal dump error: single-module pre-fire).
  - **Frequency of these errors** unknown (assume at least once per year in LHC).
  - Population of beam **halo close to collimators unknown**: 1% of beam in the halo corresponds to twice the full TEVATRON beam!
  - General uncertainties from limited knowledge of **halo beam dynamics**.



# Uncertainties II



- **Quench limits:**
  - Uncertainties in the [quench level of SC magnets](#) can reach a factor 2 easily.
- **Nuclear physics:**
  - The nuclear [physics processes](#) in the CFC collimator jaws can have up to a factor 2 uncertainties at 7 TeV.
  - Modeling of [energy deposition](#) can be affected by the limitations in the modeled geometry by up to a factor 2.
- **Impedance:**
  - LHC [resistive wall impedance](#) will be dominated by the collimator-induced impedance contributions.
  - Only tolerable with the [predicted “inductive bypass”](#) at low frequencies, which gains up to factor 100 compared to the classical thick wall theory. Never proven experimentally.
- **Collimator lifetime with strong radiation:**
  - [High dose rates](#) in the collimator jaws and other collimator parts (10-100 MGy/year).
  - Designed for robustness against radiation damage. However, [lifetime unknown](#).

# Intensity Reach versus Beam Energy for Phase I Collimation with Imperfections

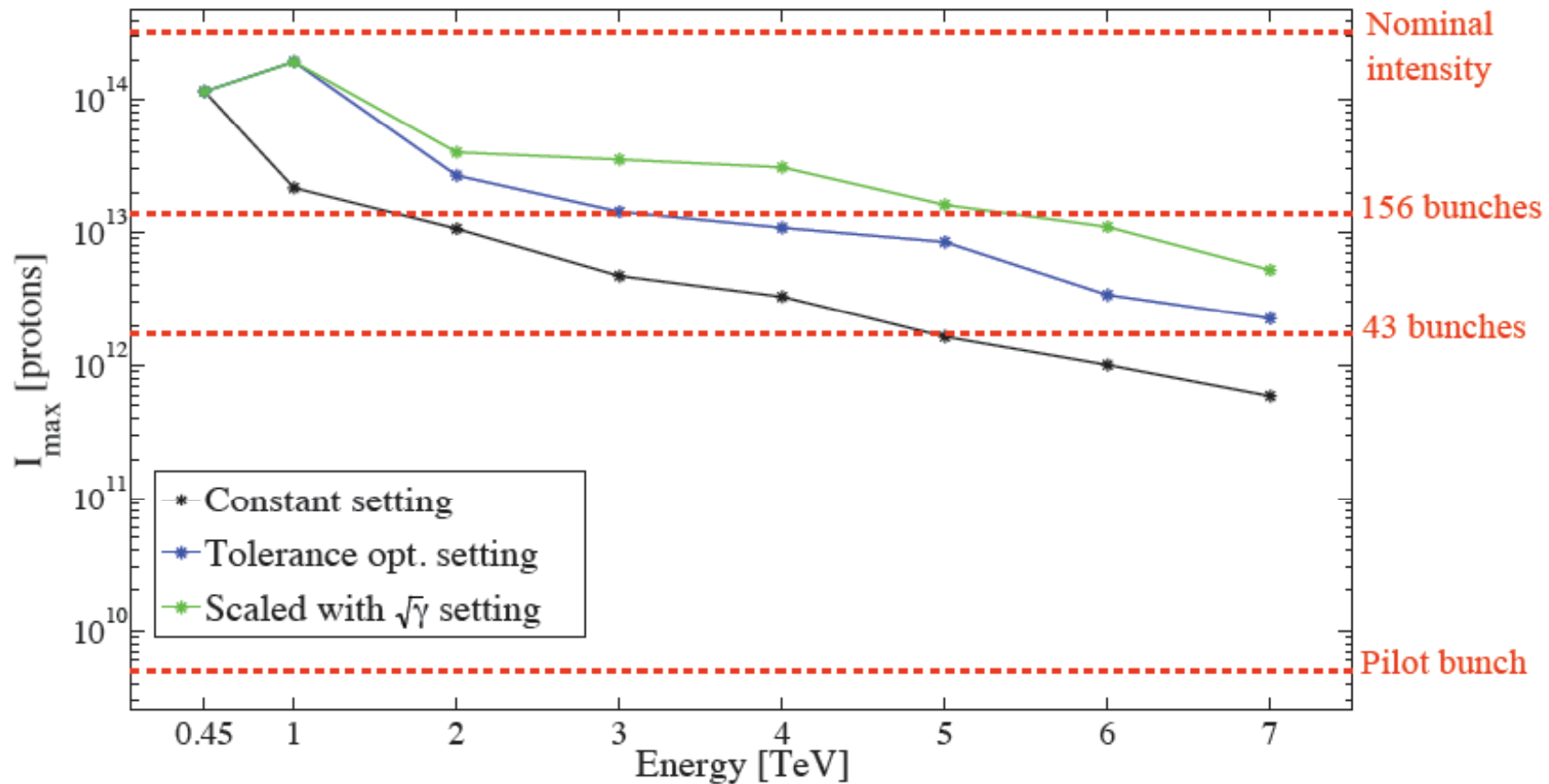
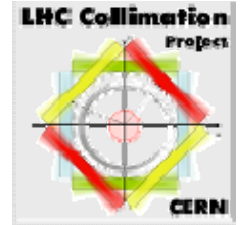

- All simulations predict need for phase II collimation upgrade!
- Phase 2 collimation project put in place (white paper, new initiative).





# Collimation: LHC Intensity Limitations I



Issue for protons	Prediction	Consequences
Collimator <b>impedance</b>	LHC impedance determined by collimators	$\leq 40\%$ of nominal intensity
Dispersion suppressors IR7	Losses of off-momentum p ( <b>single-diffractive scattering</b> )	$\leq 30\text{-}40\%$ of nominal intensity for ideal cleaning
Unavoidable <b>imperfections</b>	Efficiency reduced to less than ideal	Set up time versus <b>reduced efficiency</b>
Efficient <b>BLM thresholds</b>	Factor 3-10 uncertainty from BLM reading on knowledge of beam loss	Thresholds at least <b>factor 3 below intensity limit</b> for quench
<b>Radiation dose IR7 magnets</b> (MBW, MQW)	2-3 MGy per year	Limited lifetime of magnets (specified for 50 MGy)
<b>SC link</b> in IR3	Risk of quench for losses of uncaptured beam	$\leq 3.5\%$ of nominal intensity in <b>uncaptured beam</b>
<b>Dose on personnel</b>	High remanent radiation	<b>Limited access</b> for modifications and upgrades in cleaning insertions
<b>Environmental impact</b>	OK for ultimate intensity	Review needed for any upgrade above ultimate $\rightarrow$ <b>bypass galleries</b>



# Collimation: LHC Intensity Limitations II



Issue for protons	Prediction	Consequences
<a href="#">Vacuum equipment</a> (chambers, heating jackets)	Up to <b>8.5 MGy per year</b> and up to <b>500 W/m heating</b>	Limited lifetime
<a href="#">Collimator robustness</a> against failures	OK for accident cases with nominal intensity (450 GeV and 7 TeV), including water circuit in vacuum (up to 2 MJ)	Review for any upgrade in intensity, beam brightness, bunch structure, ...
Collimator <a href="#">jaw damage</a>	Under preparation	Limited lifetime of LHC collimators
<a href="#">Radiation to electronics</a> close to cleaning insertions	OK for nominal intensity (0.5 Gy/y)	Review needed for any upgrade
Quench downstream of local dump protection (TCDQ)	<b>MQY at 60% of quench limit</b> for nominal intensity (beam 2).	Upgrade of TCDQ should be envisaged.

Issue for ions	Prediction	Consequences
<a href="#">Fragmentation and dissociation in primary collimator</a>	Two-stage cleaning does not work.	Intensity limited to <b>~ 30% of nominal</b> .



# Example: Betatron Cleaning

